

**2 IN 1
CORDLESS HANDSTICK**

USER MANUAL

MPO7AUBK

Warning notices: Before using this product, please read this manual carefully and keep it for future reference. The design and specifications are subject to change without prior notice for product improvement. Consult with your dealer or manufacturer for details.

The diagram above is just for reference. Please take the appearance of the actual product as the standard.

THANK YOU LETTER

Thank you for choosing Midea! Before using your new Midea product, please read this manual thoroughly to ensure that you know how to operate the features and functions that your new appliance offers in a safe way.

CONTENTS

THANK YOU LETTER	01
SAFETY INSTRUCTIONS	02
PRODUCT OVERVIEW	06
OPERATION INSTRUCTIONS	07
CLEANING AND MAINTENANCE	08
TROUBLESHOOTING	14
TRADEMARKS, COPYRIGHTS AND LEGAL STATEMENT	15
DISPOSAL AND RECYCLING	16
DATA PROTECTION NOTICE	17

SAFETY INSTRUCTIONS

Intended Use

The following safety guidelines are intended to prevent unforeseen risks or damage from unsafe or incorrect operation of the appliance. Please check the packaging and appliance on arrival to make sure everything is intact to ensure safe operation. If you find any damage, please contact the retailer or dealer. Please note modifications or alterations to the appliance are not allowed for your safety concern. Unintended use may cause hazards and loss of warranty claims.

Explanation of Symbols



Danger

This symbol indicates that there are dangers to the life and health of persons due to extremely flammable gas.



Warning of electrical voltage

This symbol indicates that there is a danger to life and health of persons due to voltage.



Warning

The signal word indicates a hazard with a medium level of risk which, if not avoided, may result in death or serious injury.



Caution

The signal word indicates a hazard with a low degree of risk which, if not avoided, may result in minor or moderate injury.



Attention

The signal word indicates important information (e.g. damage to property), but not danger.



Observe instructions

This symbol indicates that a service technician should only operate and maintain this appliance in accordance with the operating instructions.

Read these operating instructions carefully and attentively before using/commissioning the unit and keep them in the immediate vicinity of the installation site or unit for later use!

SAFETY INSTRUCTIONS

- Do not place the vacuum cleaner close to heat sources, radiation sources or burning cigarette butts. Sucking in the following objects is strictly forbidden:
 - All liquids such as water and solvent;
 - Construction dust and trash such as lime and cement dust.
 - Heat sources, such as carbon butts and cigarette butts that have not been put out.
 - Sharp fragments, such as glass.
 - Flammable and explosive articles, such as gasoline and alcohol products. external timer or a separate remote control.
- This product can only be disassembled by authorized technical personnel. Disassembling without guidance is strictly forbidden.
- Children, persons with reduced physical, sensory or mental capabilities, and persons who lack knowledge and/or experience of using household appliances are strictly forbidden to use this product without special guidance!
- This product is an indoor household product, please do not use it outdoors.
- The vacuum cleaner is an electric appliance that must be used under normal use conditions. Do not leave it unattended while running.
- Do not touch the power cord, socket or power adapter with wet hands.
- Clean the dust cup when it is full before using this product.
- Turn off the power when cleaning, repairing or not using the vacuum cleaner.

- Do not immerse the vacuum cleaner in water or place it near heat sources or in the sun, so as to avoid fire.
- Use only the original power adapter that comes with the package for this product. Use of other adapters may damage this product.
- Turn off the power when taking out the battery. Do not disassemble the battery by yourself. If you need Please contact the after-sales maintenance personnel for replacement if needed. Please properly dispose of the battery when discarding the product.
- Do not touch the pole piece or jack with conductors to avoid short circuit.
- Power cut-off: Do not pull the power cord, hold the plastic part of the plug with your hand and unplug the plug.
- Do not pass the power cord of the vacuum cleaner through sharp objects, so as not to damage the power cord.
- Do not drag the power cord to move the charging base.
- Check the power supply voltage to ensure the same voltage as the charging voltage of the vacuum cleaner.
- Avoid running for a long time when the suction inlet is blocked, so as to avoid motor damage and heating deformation of the vacuum cleaner.
- Do not use the vacuum cleaner and send it to the maintenance department designated by Midea for maintenance in time under the following circumstances:

- The vacuum cleaner has obvious damage or abnormal operation condition after falling to the floor
- The power cord is damaged.

TIPS

- Longer charging time may be needed in the following circumstances.
 - When charging in a place where the indoor temperature exceeds 30°C;
 - When charging immediately after stopping running.
- Please charge the vacuum cleaner after using no matter how long it is used.
- When not charging, it is recommended to unplug the power plug in time.
- If the vacuum cleaner is not in use for a long time (more than 2 months), please unplug the power plug, but in order to ensure the battery life, please fully charge it every 2 months.
- During charging, the machine or the power adapter may heat up, which is a normal phenomenon. Please rest assured to use it.

PRODUCT OVERVIEW

Installation And Parts

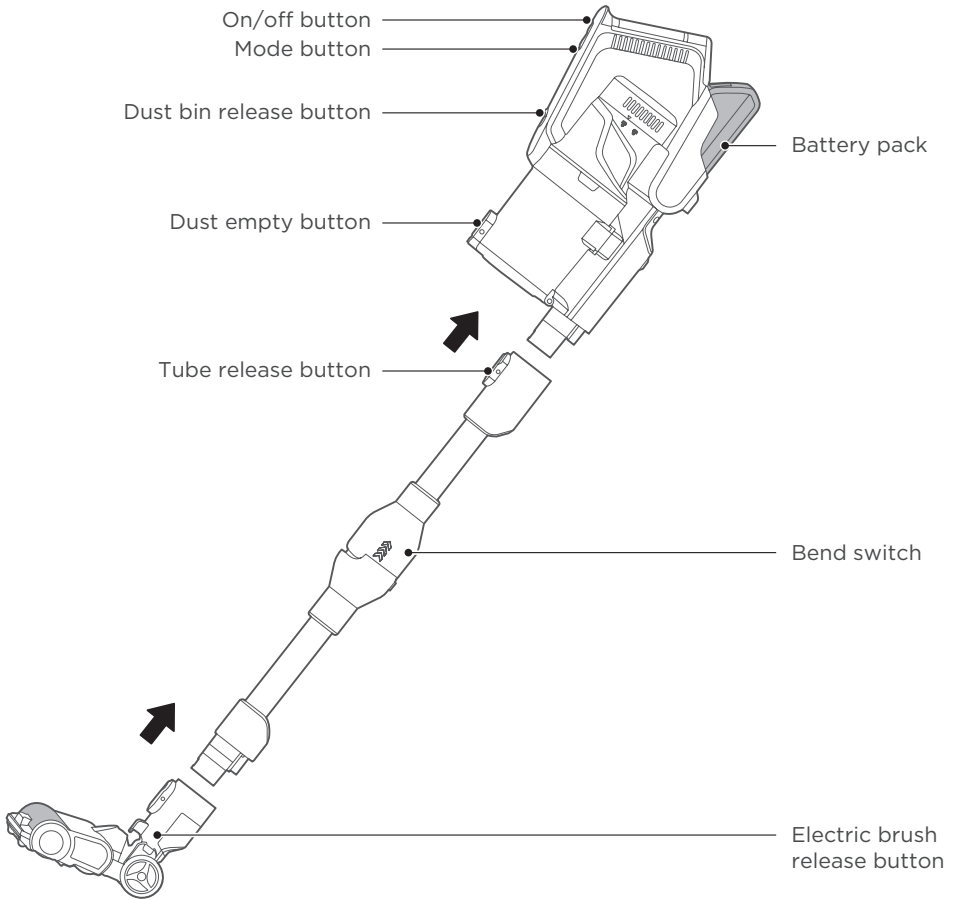

List Of Accessories



Motorized bed brush



Upholstery brush



Storage buckle assembly

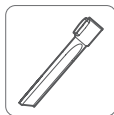

Crevice nozzle

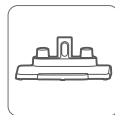

Storage rack assembly

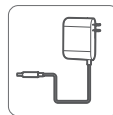

Adaptor

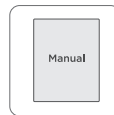

Instructions

OPERATION INSTRUCTIONS

Use of bendable tube

Pull upwards the upper sleeve of the bendable tube, and the bendable tube automatically rotates and bends.

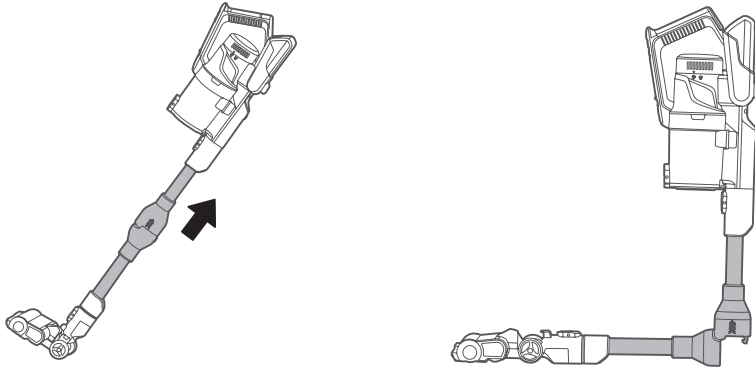

Battery Charging

NOTE

1. The battery is not charged when leaving the factory, so please fully charge the battery before use;
2. Do not charge under 5°C or above 40°C;
3. During the operation, the battery power indicator flashes when the battery runs low;
4. When the battery life of the machine is obviously shortened and the charging time is prolonged, please replace the battery with professionals. Do not disassemble and assemble the machine by yourself to avoid danger.

S/N	Operation Instructions
1	Place the machine on the storage rack stably;
2	Plug one end of the power cord into the socket and insert the other end into the charging port at the tail of the handle on the a period of full power, the indicator will go out.
3	Charging time: 5-7 hours Discharge time: About 10 minutes for High mode About 20 minutes for Intermediate mode About 70 minutes for Low-mode

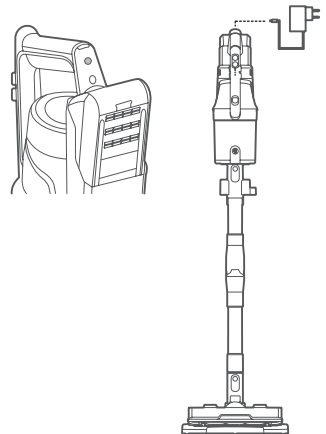

CLEANING AND MAINTENANCE

Cleaning

NOTE

1. To avoid blocking the air duct, please clean up large pieces of garbage (such as large pieces of paper and packaging film) in the area first;
2. Do not use and store batteries under 5°C or above 40°C;
3. When discarding this product, please remove the battery from the complete machine;
4. It is strictly forbidden to remodel the complete machine, accessories and replace the power
5. Battery model: BP28825A

S/N	Use of the machine
1	Press the "On/Off button" once to start;
2	Press the "On/Off button" again to stop;
3	When Indicator 1, 2 and 3 flashes simultaneously, it is an alarm that requires professional maintenance.
4	It defaults to the Intermediate mode when powered on with a full battery (Indicator 1, 2, and 3 are on simultaneously). Press the "Mode button" once for High mode (Indicator 1 and 2 is on and Indicator 3 is blue), and press the "Mode button" again for Low mode (Indicator 1 and 2 is on and Indicator 3 is off);
5	Energy indication during charging. When one of the Indicator 1 and 2 flashes, the battery power is low, and it needs to continue charging. When Indicator 1 and 2 are on the battery is fully charged, and the indicator will go out after a period of full charge.
6	Energy indication during operation(discharge): When Indicator 1 and 2 are on it shows that the 6 battery power is sufficient. When indicator 1 flashes or Indicator 2 goes off, it shows that the battery power is low. Please charge in time.

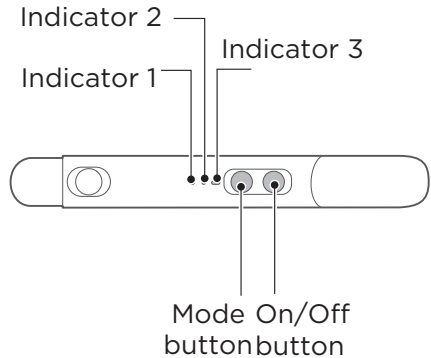
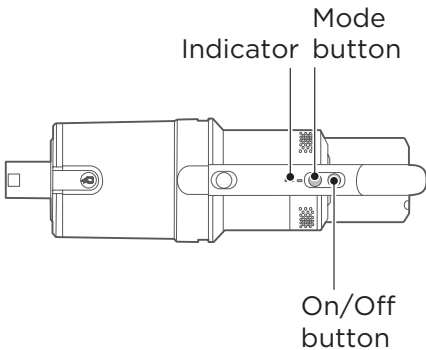

Storage And Use Of The Cleaner

NOTE

1. When the cleaner is placed on the storage station or when the storage station is placed alone, it must be placed on a horizontal ground to avoid falling and damage to the cleaner.
2. The cleaner should be used with care whether it is in work or placed on the storage station, so as not to damage the machine.

1. Installation of storage station

Install the storage rack assembly and the storage base as shown in the figure, and place the storage station vertically on the horizontal ground as shown in the right figure.

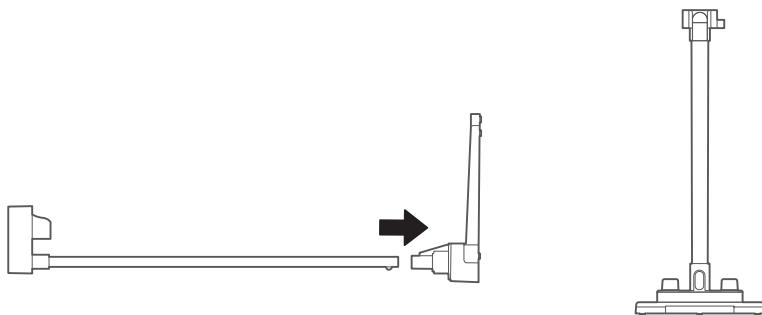

2. Storage of the cleaner

Before placing the cleaner on the storage station, please make sure once again whether the ground is horizontal and the cleaner has been turned off. Gently place the cleaner on the rack of storage station as the position shown on the below figure, then leave after the cleaner is placed stably.

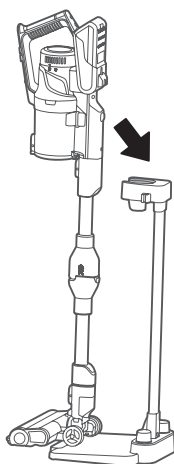

Disassembling And Cleaning Of Dust Cup

NOTE

1. To keep the suction of the vacuum cleaner, please clean the dust regularly, remove the main unit as shown in the figure, and then press the lock on the bottom cover of the dust cup to dump the dust.

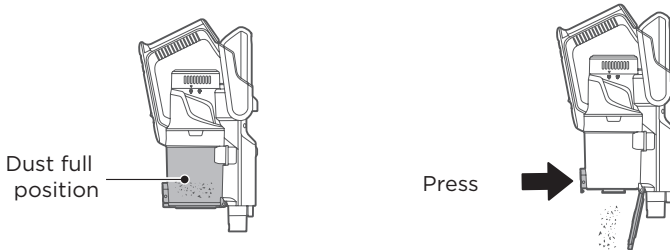

After the machine is laid flat as shown in the figure, press the lock button with one hand and take out the dust cup assembly with the other hand.

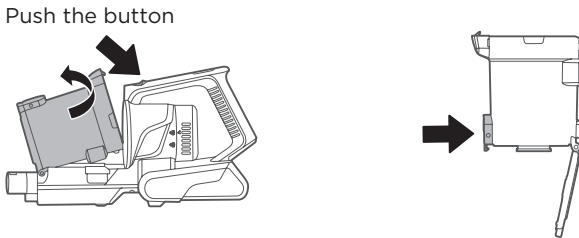

Disassembling And Cleaning Of Filter

NOTE

1. The parts in the dust cup are washable
2. Please make sure that every part has been dried after cleaning and before mounting it back!

Removal of the filter from the dust cup

1. Remove the dust cup assembly from the machine and lay it flat vertically;
2. Take out the filter sponge and filter assembly in turn.



Disassembling And Cleaning Of Dust Cup

After taking out the filter assembly, remove the cyclone cone by rotation as shown in the figure, clean it, dry it thoroughly, and then mount it back according to the disassembly procedure.

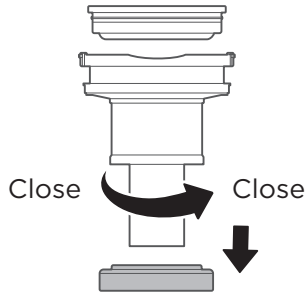

Disassembling And Cleaning Of Electric Scrubbing Brush

NOTE

1. To avoid affecting the operation of the electric scrubbing brush, please clean and maintain the roller brush and wheels when they are entangled or dirty;
 2. When disassembling and maintaining, be sure to stop the operation of the electric scrubbing brush;
 3. It is not recommended to wash the scrubbing brush with water. The entangled hair can be cleaned with scissors or blades, and the dust stuck on the roller brush can be cleaned with a brush.
1. Press the button to remove the electric scrubbing brush;

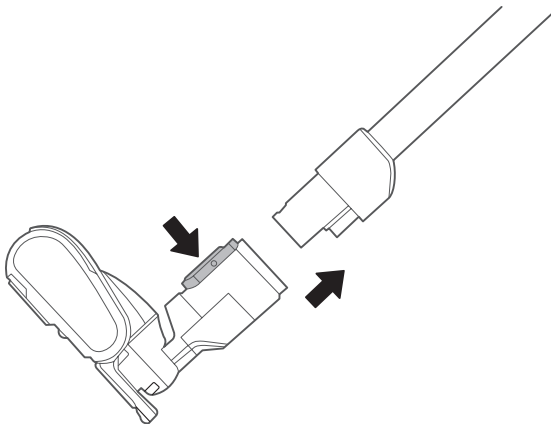

Disassembling And Cleaning Of Electric Scrubbing Brush

2. Unscrew the gland of the roller brush according to the instructions, draw the roller brush assembly to one side and clean it. Mount it back according to the disassembly procedure after cleaning.

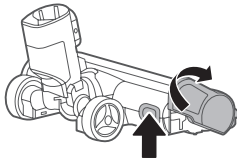

Press
Release the gland of the roller brush

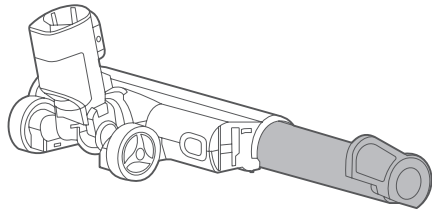

Draw out the roller brush assembly

Disassembling And Cleaning Of Electric Scrubbing Brush

NOTE

1. When dust blocks the air duct of the bed brush, please use disposable chopsticks to remove the dust.
 2. Except for the roller brush, other parts cannot be cleaned with water;
 3. During operation, do not touch the roller brush that rolls at the bottom.
 4. To avoid affecting the operation of the electric bed brush, please clean and maintain the roller brush when it is entangled or dirty.
1. Press the button to remove the electric bed brush;
 2. Pull the lock in the direction shown below, and then rotate to take out the roller brush assembly;

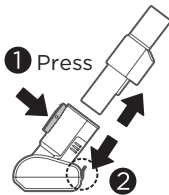

3. Wipe the inside clean with a cloth strip. If the roller brush is wrapped with hair, cut it along the roller brush with scissors and clean it up. After cleaning, mount the roller brush back according to the above disassembly steps.

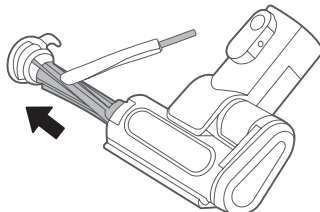

Disassembling And Cleaning Of Vent Hepa Filter

NOTE

1. Please pay attention to sharp objects such as glass to prevent injury;
 2. All parts must be completely dried before they can be mounted and used;
 3. Do not rub or exert brute force on the HEPA filter;
 4. When assembling, please make sure that the HEPA filter is mounted in place;
 5. Do not continue to use the HEPA filter when it is damaged or insufficiently cleaned and maintained.
1. After the machine is laid flat as shown in the figure, hold the machine with one hand, rotate the air vent cover with the other hand counterclockwise, and then take off the cover vertically to the right;

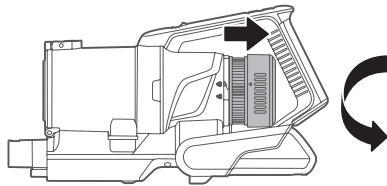

2. Remove the air vent cover, and remove the vent HEPA filter vertically to the right. The HEPA filter can be washed gently with water, but not rubbed by brute force. After being fully dried, mount it back according to the above disassembly steps.

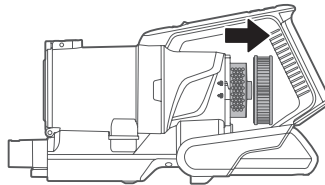

Battery Charging

S/N	Operation Instructions
1	Press the battery pack release button
2	Pull the battery pack backward
3	Replace the battery pack in reverse order

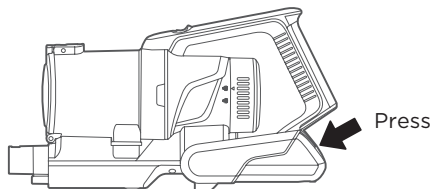

TROUBLE SHOOTING

In the case of any abnormalities in the use of this product please refer to the table below first.

Abnormality	Possible Cause	Treatment
3 indicators flash	<ul style="list-style-type: none"> Floor brush or mite removal brush entangled during rolling Too high or too low use ambient temperature 	<ul style="list-style-type: none"> Clean floor brush or mite removal brush Please use in a proper environment
Electric floor brush does not work	<ul style="list-style-type: none"> Large trash rolled in (packaging film, etc.) Rolling brush entangled in hair, etc. 	<ul style="list-style-type: none"> Remove hairs wrapped around rolling brush Remove trash
Running time becomes shorter	<ul style="list-style-type: none"> Battery ages Too high or too low use ambient temperature Battery not fully charged 	<ul style="list-style-type: none"> Contact the seller or after-sales service personnel to purchase a new battery Use in a proper environment Charge the vacuum cleaner
Suction loss	<ul style="list-style-type: none"> Excessive dust in dust cup Dust cup cotton filter clogged Floor brush or accessory suction inlets clogged Not fully dried after washing 	<ul style="list-style-type: none"> Clean up trash in time Clean cotton filter Remove blockage Dry the washed parts in a cool place for use
Unable to charge	<ul style="list-style-type: none"> Too low or too high ambient temperature when charging 	<ul style="list-style-type: none"> Charge the vacuum cleaner in an environment with proper temperature (5°C-40°C)
Battery leakage	<ul style="list-style-type: none"> Battery not used for a long time 	<ul style="list-style-type: none"> Replace the battery

TRADEMARKS, COPYRIGHTS AND LEGAL STATEMENT

 Midea logo, word marks, trade name, trade dress and all versions thereof are valuable assets of Midea Group and/or its affiliates (“Midea”), to which Midea owns trademarks, copyrights and other intellectual property rights, and all goodwill derived from using any part of an Midea trademark. Use of Midea trademark for commercial purposes without the prior written consent of Midea may constitute trademark infringement or unfair competition in violation of relevant laws.

This manual is created by Midea and Midea reserves all copyrights thereof. No entity or individual may use, duplicate, modify, distribute in whole or in part this manual, or bundle or sell with other products without the prior written consent of Midea.

All the described functions and instructions were up to date at the time of printing this manual. However, the actual product may vary due to improved functions and designs.

DISPOSAL AND RECYCLING

Important instructions for environment

Compliance with the WEEE Directive and Disposing of the Waster Product:
This product complies with EU WEEE Directive (2012/19/EU). This product bears a classification symbol for waster electrical and electronic equipment (WEEE).

This symbol indicates that this product shall not be disposed with other household wastes at the end of its service life. Used device must be returned to official collection point for recycling of electrical electronic devices. To find these collection systems please contact to your local authorities or retailer where the product was purchased. Each household performs important role in recovering and recycling of old appliance. Appropriate disposal of used appliance helps prevent potential negative consequences for the environment and human health.

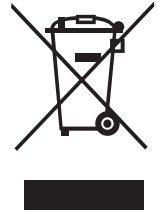

Compliance with RoHS Directive

The product you have purchased complies with EU RoHS Directive (2011/65/EU). It does not contain harmful and prohibited materials specified in the Directive.

Package information

Packaging materials of the product are manufactured from recyclable materials in accordance with our National Environment Regulations. Do not dispose of the packaging materials together with the domestic or other wastes. Take them to the packaging material collection points designated by the local authorities.



DATA PROTECTION NOTICE

For the provision of the services agreed with the customer, we agree to comply without restriction with all stipulations of applicable data protection law, in line with agreed countries within which services to the customer will be delivered, as well as, where applicable, the EU General Data Protection Regulation (GDPR).

Generally, our data processing is to fulfil our obligation under contract with you and for product safety reasons, to safeguard your rights in connection with warranty and product registration questions. In some cases, but only if appropriate data protection is ensured, personal data might be transferred to recipients located outside of the European Economic Area.

Further information are provided on request. You can contact our Data Protection Officer via **MideaDPO@midea.com**. To exercise your rights such as right to object your personal data being processed for direct marketing purposes, please contact us via **MideaDPO@midea.com**. To find further information, please follow the QR Code.



make yourself at home



www.midea.com

© Midea 2022 all rights reserved