

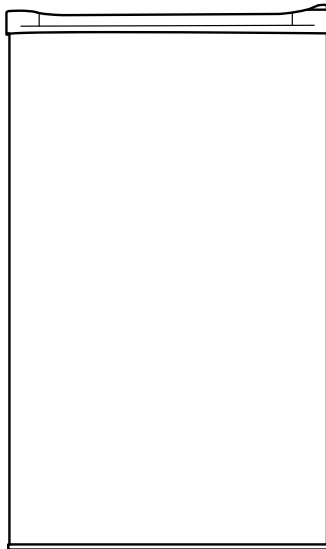

# **Instruction Manual**

## **Upright Freezer**

**Model: ARU030S1ARWW  
ARU030S1ARSS**



# CONTENTS

<b>1 Safety warnings</b>	
1.1 Warning	1-2
1.2 Meaning of safety warning symbols	3
1.3 Electricity related warnings	3
1.4 Related warnings for use	4
1.5 Warnings related to placing items	5
1.6 Warnings for energy	5
1.7 Warnings related to disposal	5
<b>2 Proper use of upright freezer</b>	
2.1 Names of components	6
2.2 Temperature-controller components	7
2.3 Placement	7
2.4 Start to use	7
2.5 Energy saving tips	7
2.6 Levelling feet	8
2.7 Door right-left change (optional)	8
<b>3 Maintenance of upright freezer</b>	
3.1 Cleaning	11
3.2 Defrost	11
3.3 Stop using	11
<b>4 Trouble shooting</b>	12

## 1 Safety warnings

### 1.1 Warning



**Warning:** risk of fire / flammable materials

**THIS** appliance is intended to be used in household and similar applications such as staff kitchen areas in shops, offices and other working environments; farm houses and by clients in hotels, motels and other residential type environments; bed and breakfast type environments; catering and similar non-retail applications.

**THIS** appliance is not intended for use by persons (including children) with reduced physical, sensory or mental capabilities, or lack of experience and knowledge, unless they have been given supervision or instruction concerning use of the appliance by a person responsible for their safety.) Children should be supervised to ensure that they do not play with the appliance.

**IF** the supply cord is damaged, it must be replaced by the manufacturer, its service agent or similarly qualified persons in order to avoid a hazard.

**DO** not store explosive substances such as aerosol cans with a flammable propellant in this appliance.

**THE** appliance has to be unplugged after use and before carrying out user maintenance on the appliance.

**WARNING:** Keep ventilation openings, in the appliance enclosure or in the built-in structure, clear of obstruction.

**WARNING:** Do not use mechanical devices or other means to accelerate the defrosting process, other than those recommended by the manufacturer.

**WARNING:** Do not damage the refrigerant circuit.

**WARNING:** Do not use electrical appliances inside the food storage compartments of the appliance, unless they are of the type recommended by the manufacturer.

**WARNING:** Please abandon the refrigerator according to local regulators for its use of flammable blowing gas and refrigerant.

**WARNING:** When positioning the appliance, ensure the supply cord is not trapped or damaged.

**WARNING:** Do not locate multiple portable socket-outlets or portable power supplies at the rear of the appliance.

**DO** not use extension cords or ungrounded ( two prong ) adapters.

**WARNING:** Risk of child entrapment. Before you throw away your old refrigerator or freezer:

–Take off the doors.

–Leave the shelves in place so that children may not easily climb inside.

**THE** refrigerator must be disconnected from the source of electrical supply before attempting the installation of accessory.



**REFRIGERANT** and cyclopentane foaming material used for the appliance are flammable. Therefore, when the appliance is scrapped, it shall be kept away from any fire source and be recovered by a special recovering company with corresponding qualification other than be disposed by combustion, so as to prevent damage to the environment or any other harm.

**WARNING:** To avoid a hazard due to instability of the appliance, it must be fixed in accordance with the instructions.

**WARNING:** Connect to potable water supply only. (Suitable for ice making machine)

**TO** Prevent A Child From Being Entrapped, Keep Out Of Reach Of Children And Not In The Vicinity Of Freezer (Or Refrigerator). (Suitable for products with locks)

## 1.2 Meaning of safety warning symbols

	The symbols indicate prohibited matters, and those behaviors are forbidden. Non-compliance with the instructions may result in product damages or endanger the personal safety of users.
	The symbols indicate matters that must be followed, and those behaviors must be strictly executed in line with the operation requirements. Non-compliance with the instructions may result in product damages or endanger the personal safety of users.
	The symbols indicate matters to pay attention to, and these behaviors shall be specially noted. Due precautions are needed or minor or moderate injuries or damages of the product will be caused.

This manual contains lots of important safety information which shall be observed by the users.

## 1.3 Electricity related warnings

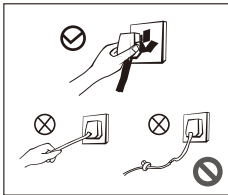

- Do not pull the power cord when pulling the power plug of the upright freezer. Please firmly grasp the plug and pull out it from the socket directly.
- Do not damage the power cord under any condition so as to ensure safety use, do not use when the power cord is damaged or the plug is worn.
- Worn or damaged power cord shall be replaced in manufacturer-authorized maintenance stations.

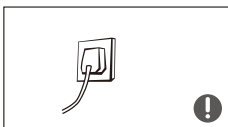

- The power plug should be firmly contacted with the socket or else fires might be caused. Please ensure that the grounding electrode of the power socket is equipped with a reliable grounding line.



- Please turn off the valve of the leaking gas and then open the doors and windows in case of leakage of gas and other flammable gases. Do not unplug the upright freezer and other electrical appliances considering that spark may cause a fire.

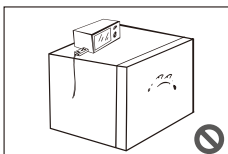

- To ensure safety, it is not recommended that to place regulators, rice cookers, microwave ovens and other appliances on the top of the upright freezer, those recommended by the manufacturer are not included. Do not use electrical appliances in the food pan.

## 1.4 Related warnings for use

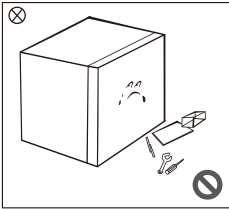

- Do not arbitrarily disassemble or reconstruct the upright freezer, nor damage the refrigerant circuit; maintenance of the appliance must be conducted by a specialist.
- Damaged power cord must be replaced by the manufacturer, its maintenance department or related professionals in order to avoid danger.

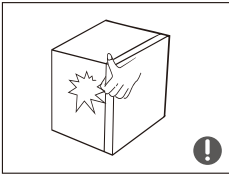

- The gaps between upright freezer doors and between doors and upright freezer body are small, be noted not to put your hand in these areas to prevent from squeezing the finger. Please be gentle when open the upright freezer door to avoid falling articles.
- Do not pick foods or containers with wet hands in the freezing chamber when the upright freezer is running, especially metal containers in order to avoid frostbite.

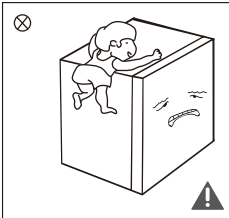

- Do not allow children to enter or climb the upright freezer to prevent that children are sealed in the upright freezer or children are injured by the falling upright freezer.
- Do not spray or wash the upright freezer; do not put the upright freezer in moist places easy to be splashed with water so as not to affect the electrical insulation properties of the upright freezer.

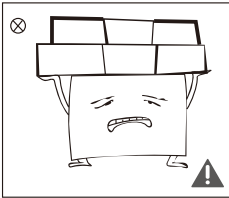

- Do not place heavy objects on the top of the upright freezer considering that objects may fall when open the door, and accidental injuries might be caused.
- Please pull out the plug in case of power failure or cleaning. Do not connect the upright freezer to power supply within five minutes to prevent damages to the compressor due to successive starts.

## 1.5 Warnings related to placing items

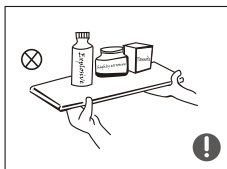

- Do not put flammable, explosive, volatile and highly corrosive items in the upright freezer to prevent damages to the product or fire accidents.
- Do not place flammable items near the upright freezer to avoid fires.

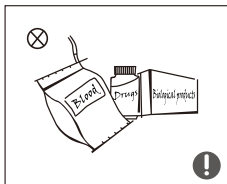

- This product is household upright freezer and shall be only suitable for the storage of foods. According to national standards, household upright freezer shall not be used for other purposes, such as storage of blood, drugs or biological products.

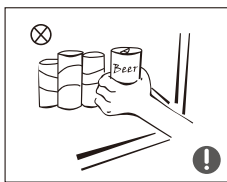

- Do not place items such as bottled or sealed container of fluid such as bottled beers and beverages in the upright freezer to prevent bursts and other losses.

## 1.6 Warnings for energy

- 1) upright freezer might not operate consistently when sited for an extended period of time below the cold end of the range of temperatures for which the upright freezer appliance is designed.
- 2) The fact that effervescent drinks should not be stored in low-temperature compartments or cabinets, and that some products such as water ices should not be consumed too cold;
- 3) The need to not exceed the storage time recommended by the food manufacturers for any kind of food and particularly for commercially quick-frozen food in food-upright freezer and frozen-food storage compartments or cabinets;
- 4) The precautions necessary to prevent an undue rise in the temperature of the frozen food while defrosting the refrigerating appliance, such as wrapping the frozen food in several layers of newspaper.
- 5) The fact that a rise in temperature of the frozen food during manual defrosting, maintenance or cleaning could shorten the storage life.
- 6) The necessity that, for doors or lids fitted with locks and keys, the keys be kept out of the reach of children and not in the vicinity of the upright freezer appliance, in order to prevent children from being locked inside.

## 1.7 Warnings related to disposal

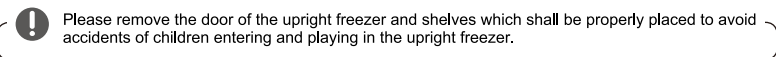
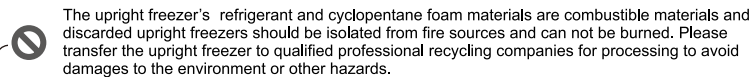

**Correct Disposal of this product:**  
This marking indicates that this product should not be disposed with other household wastes. To prevent possible harm to the environment or human health from uncontrolled waste disposal, recycle it responsibly to promote the sustainable reuse of material resources. To return your used device, please use the return and collection systems or contact the retailer where the product was purchased. They can take this product for environmental safe recycling.

## 2 Proper use of upright freezer

### 2.1 Names of components

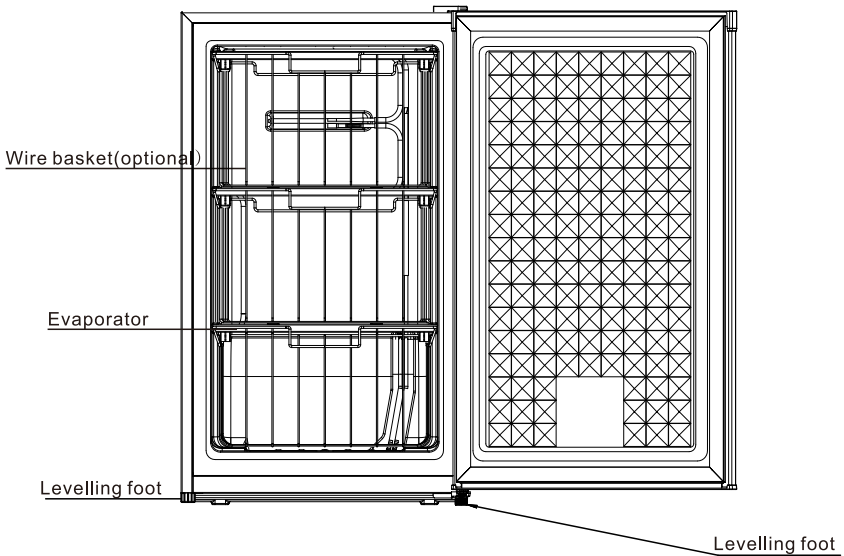

( The picture above is only for reference. The actual configuration will depend on the physical product or statement by the distributor )

- The low temperature of upright freezer may keep food fresh for a long time and it is mainly used to store frozen foods and making ice.
- The upright freezer is suitable for storage of meat, fish, shrimp, dumplings, rice balls and other foods not to be consumed in short term.
- Chunks of meat are preferably to be divided into small pieces for easy access.  
Please be noted food shall be consumed within the shelf time.



## 2.2 Temperature-controller components

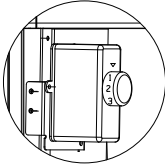

(The picture above is only for reference. The actual configuration will depend on the physical product or statement by the distributor )

- The figures do not mean specific set temperature, but temperature level.  
 "1" means the warmest setting  
 "6" means the coldest setting  
 The higher the figure is, the lower the actual temperature inside refrigerator shall be.  
 "OFF" means stop running.

## 2.3 Placement

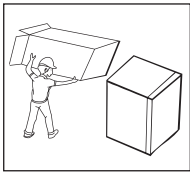

- Before using the upright freezer, remove all packaging materials including bottom cushions and foam pads and tapes inside the upright freezer , tear off the protective film on the door and the upright freezer body.

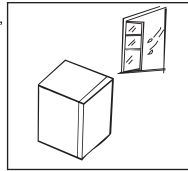

- The upright freezer should be placed in a well-ventilated indoor place; the ground shall be flat, and sturdy.

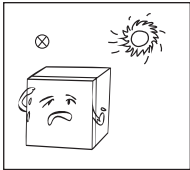

- Keep away from heat and avoid direct sunlight. Do not place the upright freezer in moist or watery places to prevent rust or reduction of insulating effect.

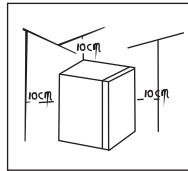

- The top space of the upright freezer shall be greater than 30cm, and the distances from both sides and backside shall be more than 10cm to facilitate heat dissipation.

## 2.4 Start to use

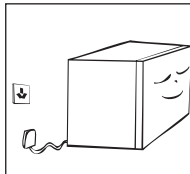

- The upright freezer shall stay for half an hour before connecting power when it is firstly started.
- The upright freezer shall run 2 to 3 hours before loading fresh or frozen foods; the upright freezer shall run for more than 4 hours in summer in advance considering that the ambient temperature is high.

## 2.5 Energy saving tips

- The appliance should be located in the coolest area of the room, away from heat producing appliances or heating ducts, and out of the direct sunlight.
- Let hot foods cool to room temperature before placing in the appliance. Overloading the appliance forces the compressor to run longer. Foods that freeze too slowly may lose quality, or spoil.
- Be sure to wrap foods properly, and wipe containers dry before placing them in the appliance. This cuts down on frost build-up inside the appliance.
- Appliance storage bin should not be lined with aluminum foil, wax paper, or paper toweling. Liners interfere with cold air circulation, making the appliance less efficient.
- Organize and label food to reduce door openings and extended searches. Remove as many items as needed at one time, and close the door as soon as possible.

## 2.6 Levelling feet

Schematic diagram of the leveling feet

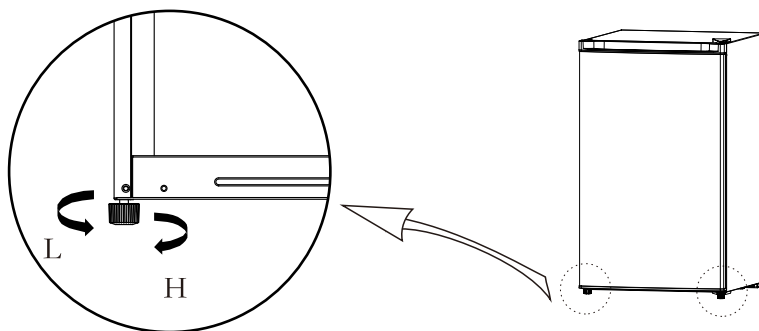



(The picture above is only for reference. The actual configuration will depend on the physical product or statement by the distributor)

Adjusting procedures:

- a. Turn the feet clockwise to raise the upright freezer;
- b. Turn the feet counterclockwise to lower the upright freezer;
- c. Adjust the right and left feet based on the procedures above to a horizontal level.

## 2.7 Door right-left change (optional)

List of tools to be provided by the user	
	Cross screwdriver
	Thin-blade screwdriver
	Masking tape

Parts to be used for door reverse			
Number	Name	Number	Note
1	Upper hinge	1	Pre-installed on the refrigerator, still used when door is reversed
2	Upper hinge cover	1	Pre-installed on the refrigerator, still used when door is reversed
3	Pin	2	Pre-installed on the refrigerator, still used when door is reversed
4	Screw	5	Pre-installed on the refrigerator, still used when door is reversed
5	Shaft sleeve	1	Pre-installed on the end cover of the door, still used when door is reversed
6	Lower hinge assembly	1	Pre-installed on the refrigerator, still used when door is reversed
7	Leveling foot	1	Pre-installed on the refrigerator, still used when door is reversed

1) Power off the refrigerator, and remove all objects .

2) Dismantle the hinge cover, screws upper hinge and shaft sleeve, and remove the pins from the other side.

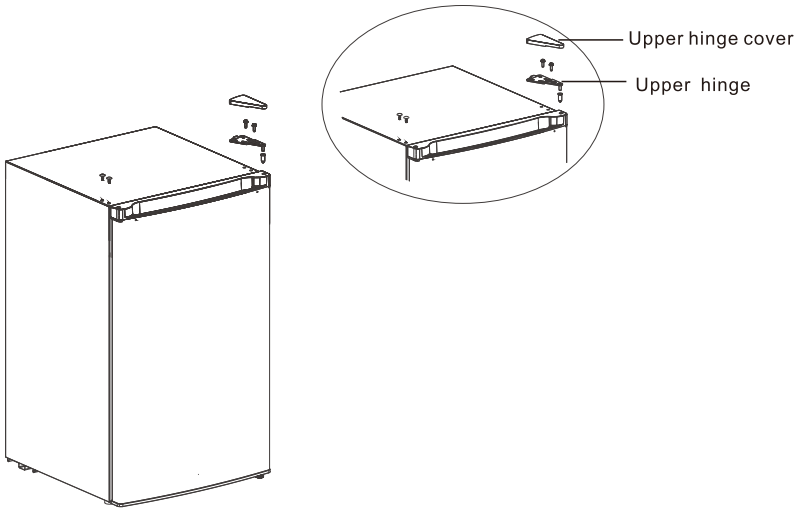

3) Remove the door;

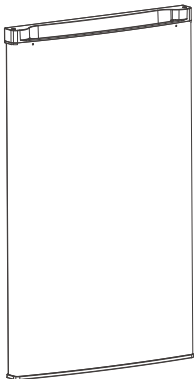

4) Dismantle the lower hinge assembly and levelling foot;

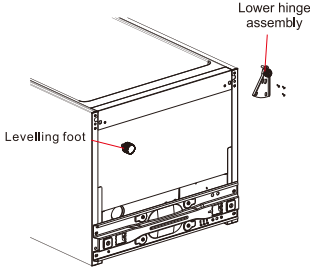

5) Install the lower hinge assembly removed on the right to the left side of the cabinet, and the levelling foot to the right side of the cabinet.

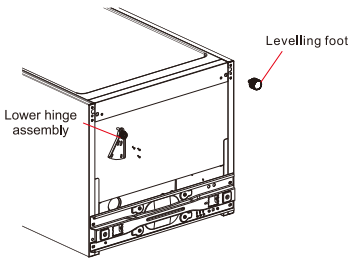

6) Install the door on the lower hinge assembly, and then install the upper hinge, hinge cover, shaft sleeve and pins in sequence.

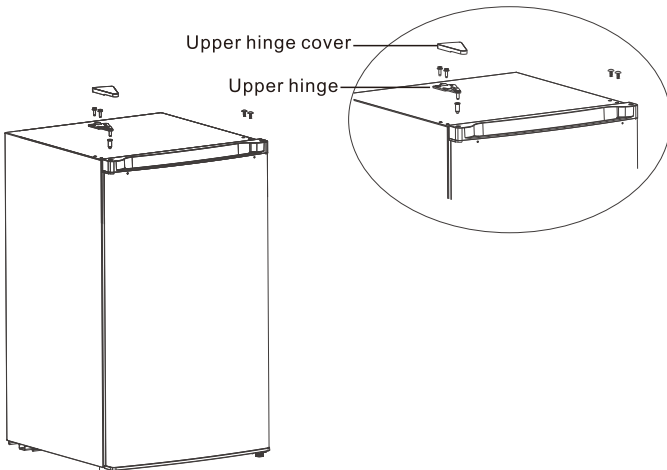

(The picture above is only for reference. The actual configuration will depend on the physical product or statement by the distributor)

## 3 Maintenance of upright freezer

### 3.1 Cleaning

- Dusts behind the upright freezer and on the ground shall be timely cleaned to improve the cooling effect and energy saving.
- Check the door gasket regularly to make sure there are no debris. Clean the door gasket with a soft cloth dampened with soapy water or diluted detergent.
- The interior of the upright freezer should be cleaned regularly to avoid odor.
- Please turn off the power before cleaning interior, remove all foods, drinks, shelves, drawers, etc.
- Use a soft cloth or sponge to clean the inside of the upright freezer, with two tablespoons of baking soda and a quart of warm water. Then rinse with water and wipe clean. After cleaning, open the door and let it dry naturally before turning on the power.
- For areas that are difficult to clean in the upright freezer (such as narrow sandwiches, gaps or corners), it is recommended to wipe them regularly with a soft rag, soft brush, etc. and when necessary, combined with some auxiliary tools (such as thin sticks) to ensure no contaminants or bacterials accumulation in these areas.
- Do not use soap, detergent, scrub powder, spray cleaner, etc., as these may cause odors in the interior of the upright freezer or contaminated food.
- Clean the bottle frame, shelves and drawers with a soft cloth dampened with soapy water or diluted detergent. Dry with a soft cloth or dry naturally.
- Wipe the outer surface of the upright freezer with a soft cloth dampened with soapy water, detergent, etc., and then wipe dry.
- Do not use hard brushes, clean steel balls, wire brushes, abrasives (such as toothpastes), organic solvents (such as alcohol, acetone, banana oil, etc.), boiling water, acid or alkaline items, which may damage the cooler surface and interior. Boiling water and organic solvents such as benzene may deform or damage plastic parts.
- Do not rinse directly with water or other liquids during cleaning to avoid short circuits or affect electrical insulation after immersion.



 Please unplug the upright freezer for defrost and cleaning.

### 3.2 Defrost

- upright freezer shall be manually defrosted.

Disconnect the plug from the wall socket, open the door and remove all the food to a cool place.

It is recommended to remove the frost by a plastic scraper, or let the temperature rise naturally until the frost melts. Then wipe away the remaining ice and water, and plug in socket for switching on the freezer.

Other mechanical devices or other means shall not be used to accelerate except those recommended by the manufacturer. Do not damage the

 refrigerant circuit.

### 3.3 Stop using

Power failure: Foods can be preserved for a couple of hours even in summer in case of power failure; it is recommended to reduce the frequency of opening door and do not put fresh foods into the upright freezer.

Long-time nonuse: Please unplug the upright freezer left unused for a long time for cleaning.

Keep the door open to avoid the bad odor.

Moving: Do not turn upside or vibrate the upright freezer, the carrying angle can not be greater than 45°. Do not hold the door and hinge when moving this unit.

 Continuous operation is recommended when the upright freezer is started. Please do not stop the upright freezer under normal circumstances so as not to affect the upright freezer's service life.

## 4 Trouble shooting

The following simple issues can be handled by the user. Please call the after-sale service department if the issues are not settled.

Not work	Whether the upright freezer is plugged and connected to power; Low voltage; Whether temperature control knob is in the work area; Failure power or tripping circuit.
Odor	Odorous foods should closely wrapped; Whether foods are rotten; Whether the interior shall be cleaned.
Long-term operation of compressor	It is normal that upright freezer operates for longer time in summer when the ambient temperature is higher; Do not put too much food in the upright freezer at one time; Do not put foods until they are cooled; Frequent opening of upright freezer door; Thick frost layer (defrost is needed).
Door can not be properly closed	The upright freezer door is stuck by food packages; Too much food; Unbalanced upright freezer.
Loud noises	Whether the floor is flat, whether the placement of upright freezer is stable; Whether the upright freezer accessories are properly placed.
Transient difficulty in door opening	After refrigeration, there will be pressure difference between the inside and outside of the upright freezer to result in transient difficulty in door opening. This is a normal physical phenomenon.
Over heat on sidewall	The upright freezer enclosure may emit heat during operation specially in summer, this is caused by the radiation of the condenser, and it is a normal phenomenon.
Surface Condensation	Condensation: condensation phenomenon will be detected on the exterior surface and door seals of the upright freezer when the ambient humidity is large, this is a normal phenomenon, and the condensation can be wiped away with a dry towel.
Airflow sound Buzz Clatter	Refrigerants circulating in the refrigerant lines will produce eruption of sound and grunts which is normal does not affect the cooling effect. Buzz will be generated by running compressor specially when starting up or shutting down. The solenoid valve or electric switch valve will clatter which is a normal phenomenon and does not affect the operation.



## ArcticKing Refrigerator Warranty

Your product is protected by this warranty:

Warranty service must be obtained from Classic Consumer Services or an authorized Midea servicer.

### Warranty

- One year full warranty from original purchase date.

ArcticKing, through its authorized servicers will:

- Pay all costs for repairing or replacing parts of this appliance which prove to be defective in materials or workmanship.

Consumer will be responsible for:

- Diagnostics, removal, transportation and reinstallation cost required because of service.
- Costs of service calls that are a result of items listed under **NORMAL RESPONSIBILITIES OF THE CONSUMER\*\***

ArcticKing replacement parts shall be used and will be warranted only for the period remaining on the original warranty.

### **NORMAL RESPONSIBILITIES OF THE CONSUMER\*\***

This warranty applies only to products in ordinary household use, and the consumer is responsible for the items listed below:

1. Proper use of the appliance in accordance with instructions provided with the product.
2. Routine maintenance and cleaning necessary to keep the good working condition.
3. Proper installation by an authorized service professional in accordance with instructions provided with the appliance and in accordance with all local plumbing, electrical and / or gas codes.
4. Proper connection to a grounded power supply of sufficient voltage, replacement of blown fuses, repair of loosened connections or defects in house wiring.
5. Expenses for making the appliance accessible for servicing.
6. Damages to finish after installation.

### **EXCLUSIONS**

This warranty does not cover the following:

- 1) Failure caused by damage to the unit while in your possession (other than damage caused by defect or malfunction), by its improper installation, or by unreasonable use of the product, including without limitation, failure to provide reasonable and necessary maintenance or to follow the written Installation and Operating Instructions.
- 2) Products purchased "as-is" or refurbished are not covered by this warranty.
- 3) Food loss caused by refrigerator or freezer failure.
- 4) Service calls to repair or replace consumables such as water filters, light bulbs air filters etc., or handles, knobs and other cosmetic parts.
- 5) Product that has been transferred from its original owner.
- 6) Interior or exterior rust on the unit.
- 7) Damages caused by services performed by persons other than authorized Midea servicers; use of parts other than Midea replacement parts; obtained from persons other than such Midea customer service; or external causes such as abuse, misuse, inadequate power supply or acts of God.
- 8) Service calls resulting from improper installation of your product.
- 9) Service calls to instruct you on the use of your product.
- 10) Surcharges including, but not limited to, any after hour, weekend, or holiday service calls, tolls, ferry trip charges, or mileage expense for service calls to remote areas, including the state of Alaska.
- 11) If the unit is put to commercial, business, rental, or other use or application other than for consumer use, we make no warranties, express or implied, including but not limited to, any implied warranty of merchantability or fitness for particular use or purpose.
- 12) Product that has been removed outside the USA or Canada.
- 13) Products without original serial numbers or products that have serial numbers which have been altered or cannot be readily determined.

Note: Some states do not allow the exclusion or limitation of incidental or consequential damages. So this limitation or exclusion may not apply to you.

### **IF YOU NEED SERVICE**

Keep your bill of sale, delivery slip, or some other appropriate payment record.

The date on the bill established the warranty period should service be required.

If service is performed, it is in your best interest to obtain and keep all receipts.

This written warranty gives you specific legal rights. You may also have other rights that vary from state to state.

Service under this warranty must be obtained by following these steps, in order:

1. Contact Classic Consumer Services or an authorized ArcticKing servicer at 1-866-646 4332.
2. If there is a question as to where to obtain service, contact our consumer relations Department.

For more information, please visit our website  
[www.midea.com](http://www.midea.com)

