



Before using your washing machine, please read this manual carefully and keep it for future reference.

Twin Tub Washing Machine

OWNER'S MANUAL

MSW-7118P

Read This Manual

Inside you will find many helpful hints on how to use and maintain your washing machine properly. Just a little preventative care on your part can save you a great deal of time and money over the life of your washing machine. You'll find many answers to common problems in the chart of troubleshooting tips. If you review the chart of troubleshooting tips first, you may not need to call for service.

CONTENTS

SAFETY INSTRUCTIONS

- Safety precaution 2
- Explanation of the symbols:..... 2

INSTALLATION

- Product description 4
- Unpacking the washing machine 4
- Installation area 5
- Change the position of the drain hose 5

OPERATIONS

- Control panel 6
- Preparation before washing 6
- Washing..... 6
- Rinse..... 6
- Spin..... 7
- Refer to the following table to select spinning time.... 7
- Reference of laundry quantity corresponding to different capacities.. 7
- Laundry volume and detergent dosage reference..... 7
- Special functions..... 9

Maintenances

- Cleaning and Care 10
- Cleaning the cabinet..... 10
- Cleaning the inlet filter..... 10
- Anti-freezing protection..... 10
- Operation when objects are dropped into the outside of the spin tub..... 11
- Trouble shooting..... 11
- Technical specifications..... 12

SAFETY INSTRUCTIONS

Safety precaution

For your safety, the information in this manual must be followed to minimize the risk of fire or explosion, electric shock, or to prevent property damage, personal injury or loss of life.

This appliance is not intended for use by persons (including children) with reduced physical, sensory or mental capabilities, or lack of experience and knowledge, unless they have been given supervision or instruction concerning use of the appliance by a person responsible for their safety. Children should be supervised to ensure that they do not play with the appliance.

If the supply cord is damaged, it must be replaced by the manufacturer, its service agent or similarly qualified persons in order to avoid a hazard.

The new hose-sets supplied with the appliance are to be used and that old hose-sets should not be reused.

The openings must not be obstructed by a carpet.

This appliance is intended to be used in household and similar applications such as:

- staff kitchen areas in shops, offices and other working environments;
- farm houses;
- by clients in hotels, motels and other residential type environments;
- bed and breakfast type environments;
- areas for communal use in blocks of flats or in launderettes.

WASH RATED CAPACITY	7.0 kg
SPIN RATED CAPACITY	3.6kg
MAXIMUM WATER PRESSURE	0.6MPa

Explanation of the symbols:



Warning!

This combination of symbol and signal word indicates a potentially dangerous situation which may result in death or serious injuries unless it's avoided.



Caution!

This combination of symbol and signal word indicates a potentially dangerous situation which may result in slight or minor injuries or damage to property and the environment.



Note!

This combination of symbol and signal word indicates a potentially dangerous situation which may result in slight or minor injuries.

SAFETY INSTRUCTIONS

Do not dismantle the machine by yourself.



Forbid dismantling

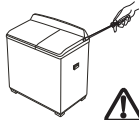

This appliance is for indoor use only. Do not install the machine in damp or rainy environment to avoid electric shock, fire, machine failure, or deformation. Do not spray water directly to the machine.

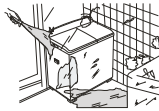

Do not place inflammable materials like burning candle, mosquito incense, cigaret etc. or heating source like electric stove, calorifier etc. on the machine. Do not let baby sit on it or place heavy things on it.

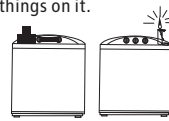

Do not wash clothes that are stained with kerosene, petrol, alcohol, and other flammable substance. Do not wash down-filled coat, raincoat or similar clothes.

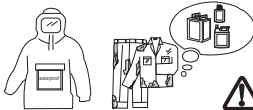

Make sure that the water inlet hose is connected and the tap is opened before washing.

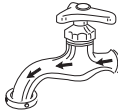

Do not exceed the max. water level to avoid water overflowing and machine failure.

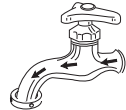

Do not let baby climb to the machine or play near running tub to avoid accident. Do not put hands into the tub before it stopping running.

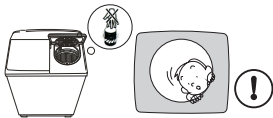

If use warm water, the water temperature should not exceed 50°C.



To avoid electric shock resulting from electric leakage, please connect grounding wire of the plug properly.

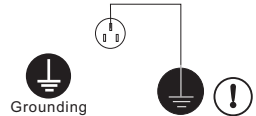

Grounding



Wipe off dirty and dust on the plug often to prevent poor contact with power supply.



Do not insert or unplug the plug with wet hands to avoid electric shock.

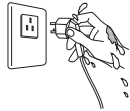

Do not replace power cord by yourself.



If the supply cord is damaged, it must be replaced by the manufacturer, its service agent or similarly qualified persons in order to avoid a hazard.

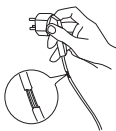

Insert the plug tightly when use. Unplug the plug from socket after use.

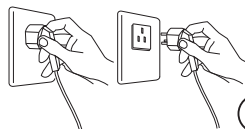

Do not pull the cord when unplug the plug.



INSTALLATION

■ Product description

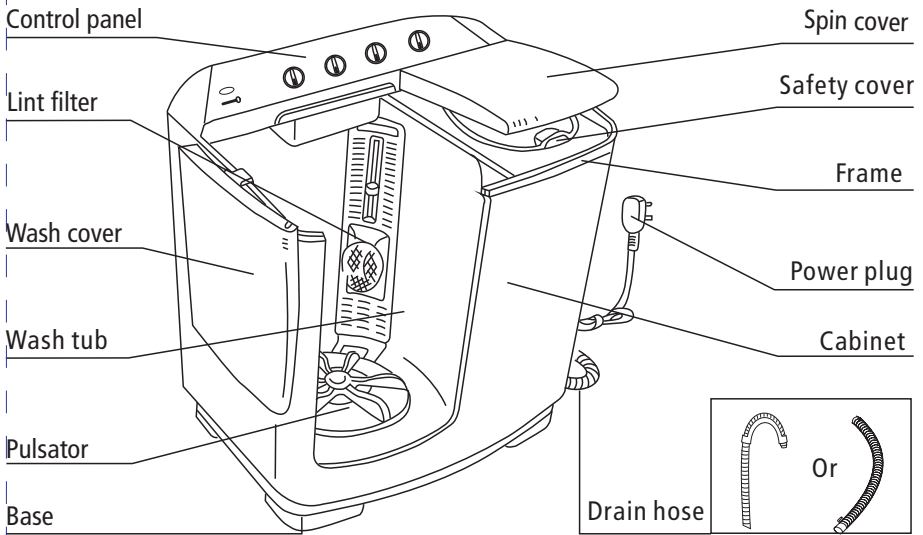

📌 Note!

- The product line chart is for reference only, please refer to real product as standard.

Accessories

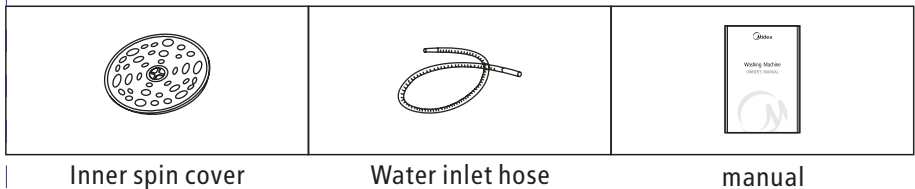

■ Unpacking the washing machine

⚠ Warning!

- Packaging material (e.g. Films, Styrofoam) can be dangerous for children.
- There is a risk of suffocation ! Keep all packaging well away from children.

1. Remove the cardboard box and styrofoam packing.
2. Lift the washing machine and remove the base packing.
3. Remove the tape securing the power supply cord and drain hose.
4. Remove the inlet hose from the drum.

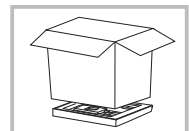

INSTALLATION

■ Installation area

⚠ Warning!

- Stability is important to prevent the product from wandering!
- Make sure that the product should not stand on the power cord.

Before installing the machine, the location characterized as follows shall be selected:

1. Rigid, dry, level surface and Avoid direct sunlight
2. Sufficient ventilation, Room temperature is above 0°C
3. Keep far away from the heat resources such as coal or gas.

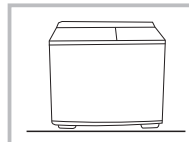
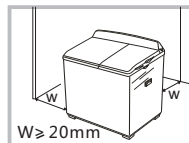

■ Change the position of the drain hose

The ex-factory installation position of the drain hose is located at the spin side. According to the installation site, the drain hose can also be installed at the wash side of the machine. The method is as follows:

1. Unplug the power cord and empty water in the drain hose completely.
2. Spread a piece of soft cloth on the floor (e.g. a blanket) and place the washing machine on it gently.
3. Take the drain hose out from the buckle at the spin side, and put it into the buckle at the wash side.
4. Hang up the drain hose kit.

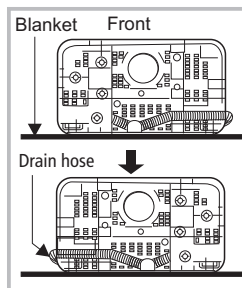

There are two ways to place the end of drain hose:

1. For lower drain system

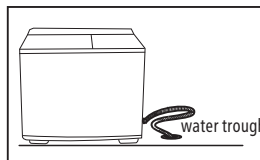
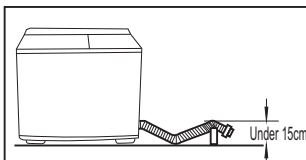
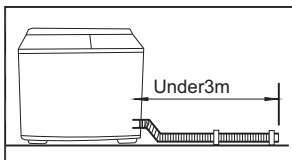

2. For upper drain system

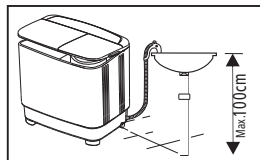
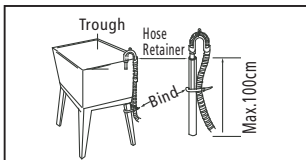
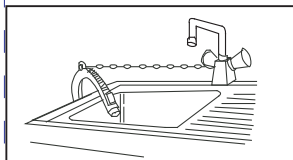

⚠ Warning!

- Do not kink or protract the drain hose.
- Position drain hose properly, otherwise damage might result of water leakage.
- If drain hose is too long, do not force it into machine as it will cause abnormal noises.

OPERATIONS

Control panel

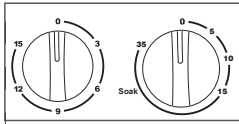

Wash timer

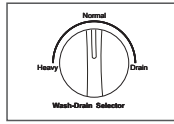

Drain selector

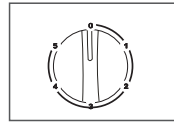

Spin timer

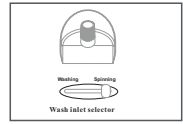

Water inlet selector

Note!

- The product line chart is for reference only, please refer to real product as standard.

- Wash timer: be used to select required washing time.
- Spin timer: be used to select required spinning time.
- Wash-Drain selector: For washing or rinsing, select " Normal" or " Heavy" . For draining ,select " Drain" .
- Water inlet: be used to inject water.

Preparation before Washing

Warning!

- The maximum gradient of the supporting surface for the washing machine should not exceed 2°.
- Do not tear down electrical wires and components in the machine by yourself.
- There are holes on the base for ventilation. These holes should not be blocked by foreign objects (carpets, etc.).
- Never connect the grounding wire with the live wire, or it may lead to an electric shock.
- Check that there are no objects such as coins, hairpins, mud or sand in the pocket.
- Strings should be knotted in advance to prevent entanglement.
- Clothes can be classified for washing according to the texture, dirty degree and color.
- For small pieces (e.g., stockings) or fluffy clothes, put them into a nylon net for washing.

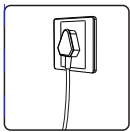

Plug in

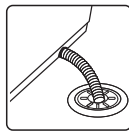

Put down the drain

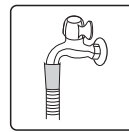

Open tap



load and Close door

Washing



Open the door
Add detergent

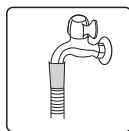

Arrived after the water
level, Close the tap

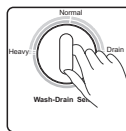

Choose washing
program

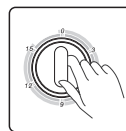

Choose the washing time
To start washing clothes



Drain

OPERATIONS

Rinse

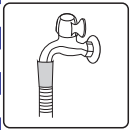

Open tap

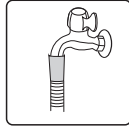

Arrived after the water level, Close the tap

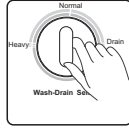

Choose washing program

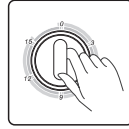

Choose the washing time To start washing clothes

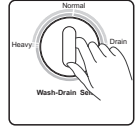

Drain

Spin

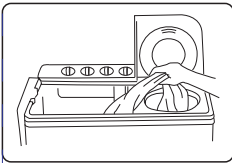

Shake out the laundry and put them into the spin tub.

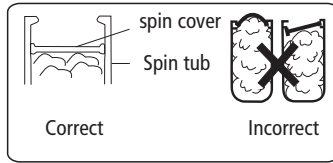

Put the inner spin cover on the laundry. Confirm the inner spin cover is placed horizontally.

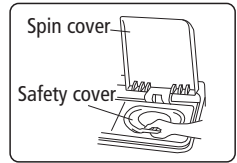

Close the safety cover and the spin cover.

Refer to the following table to select spinning time

Washing materials	Silk	Light clothes (fiber/blended)	Knitwear (fiber)	Underwear (cotton)	Slipover (cotton/linen)	Toweling coverlet (cotton)
Spin time	About 50 seconds	About 1 minute	About 1-2 minutes	About 2-3 minutes	About 3-4 minutes	About 5 minutes

Reference of laundry quantity corresponding to different capacities

Laundry Capacity	Shirt about 500 g	Uniform about 650 g	Jeans about 900 g	Jacket about 1600 g
2.0kg Capacity	about 4 pcs.	about 3 pcs.	about 2 pcs.	about 1 pcs.
3.0kg Capacity	about 6 pcs.	about 4 pcs.	about 3 pcs.	about 1 pcs.
3.6kg Capacity	about 7 pcs.	about 5 pcs.	about 4 pcs.	about 2 pcs.
4.6kg Capacity	about 9 pcs.	about 6 pcs.	about 5 pcs.	about 2 pcs.
5.0kg Capacity	about 10 pcs.	about 7 pcs.	about 5 pcs.	about 3 pcs.
5.5kg Capacity	about 11 pcs.	about 8 pcs.	about 6 pcs.	about 3 pcs.
6.0kg Capacity	about 12 pcs.	about 9 pcs.	about 6 pcs.	about 3 pcs.
7.0kg Capacity	about 14 pcs.	about 10 pcs.	about 7 pcs.	about 4 pcs.
7.5kg Capacity	about 15 pcs.	about 11 pcs.	about 8 pcs.	about 4 pcs.
8.0kg Capacity	about 16 pcs.	about 11 pcs.	about 8 pcs.	about 4 pcs.
8.5kg Capacity	about 17 pcs.	about 12 pcs.	about 9 pcs.	about 5 pcs.
10.0kg Capacity	about 20 pcs.	about 15 pcs.	about 10 pcs.	about 6 pcs.
12.0kg Capacity	about 24 pcs.	about 18 pcs.	about 13 pcs.	about 7 pcs.

OPERATIONS

■ Laundry volume and detergent dosage reference

Fabric type	Laundry capacity (kg)	Water level	Water flow	Wash time (minutes)	Detergent amount (g)
Synthetics, silk, Delicate fabrics	0-3.0 3.0-4.5	Low Mid	Normal	3 3-5	About 36 About 46
Cotton or linen	0-4.5 4.5-7.0	Mid High	Normal	7 7-10	About 46 About 55
Heavy soils	0-4.5 4.5-7.0	Mid High	Heavy	10 10-35(soak 20)	About 46 About 55

OPERATIONS

■ Special functions

For machines having the function only

Soak function

For seriously stained clothes, soak wash is useful to achieve better wash result. 15-35 minutes of the wash timer is for soak wash:(illustrate as follows)

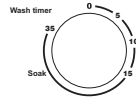
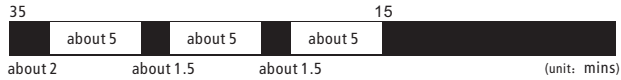

Total: 35 (mins) ■ Work time □ Static time

Buzzer function

Function of the buzzer is to alarm finish of washing, and it is helpful to control wash process. Buzzer will alarm the completion of washing.

MAINTENANCES

■ Cleaning and care

⚠ Warning!

- Before your maintenance starts, please unplug the machine and close the tap.

■ Cleaning the cabinet

Proper maintenance on the washing machine can extend its working life. The surface can be cleaned with diluted non-abrasive neutral detergents when necessary. If there is any water overflow, use the wet cloth to wipe it off immediately. No sharp items are allowed.

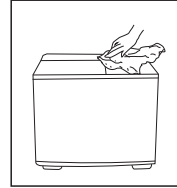

📌 Note!

- Formic acid and its diluted solvents or equivalent are forbidden, such as alcohol, solvents or chemical products, etc.

■ Cleaning the inlet filter

📌 Note!

- Inlet filter must be cleaned if there is less water.

Lint filter clean

1. Press the button head, and pull the lint filter out.
2. Turn the filter net inside out, and rinse it in water.
3. After inserting the claw, press the button to insert it into place.
4. A sound of "ba" means proper installation.

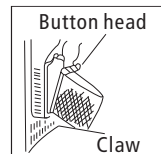

■ Anti-freezing protection

To prevent from freezing:

1. Turn off the water tap, remove the water inlet hose and empty water in the water inlet hose completely.
2. Lay the drain hose and turn the drain selector knob to the "Drain" position to empty the water in the tub.

If the water is frozen, please take the following steps:

1. Put the water inlet hose into warm water of about 50°C.
2. Keep about 2 liters of warm water below 50°C in the wash tub for about 10 minutes and then lay the drain hose and turn the wash drain selector knob to the "Drain" position to empty the water.



MAINTENANCES

3. Fit the water inlet hose and turn on the water tap to confirm water filling and draining work properly.

■ Operation when objects are dropped into the outside of the spin tub

1. Remove all screws on the frame with a screw driver and loosen the connector of the brake belt .
2. Pull up the frame with both hands and turn it backwards.
3. Take out the clothes dropped into the outside of the spin tub.
4. Fasten the connector of the brake belt ,Press the frame to reset and tighten screws.

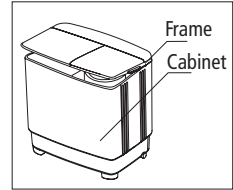

■ Trouble shooting

If the following symptoms occur, please disconnect the power plug and perform the following checks:

Symptom	Reason
The washing machine does not work.	<ul style="list-style-type: none">● Check that the power supply is in good condition.● Check that the power plug is inserted properly.● Check that the wash timer knob or the spin timer knob is not in the "0" position.
The drain hose does not work.	<ul style="list-style-type: none">● Check that the drain hose is not laid too high.● Check that the drain hose is not frozen.● Check that the drain hose is not blocked by foreign matter.
There is abnormal noise during washing.	<ul style="list-style-type: none">● Check that there are no coins or any other foreign objects dropped into the wash tub.
There is abnormal noise and violent vibration during spinning.	<ul style="list-style-type: none">● Check that the washing machine is placed on flat, stable floor.● Check that clothes are evenly distributed in the spin tub.● Check that there are no washing materials or foaming debris dropped into the outside of the spin tub.

MAINTENANCES

■ Technical specifications

Power Supply	Maximum Water Pressure				Maximum Time			
240V~,50Hz	0.6MPa				wash:15 min	soak wash:35 min	Spin:5 min.	
Model	Washing Capacity		Rated Power		Dimension W*D*H(mm)	Water volume H:/M:/L:(L)	Net Weight	Pump Rated Power
	Wash	Spin	Wash	Spin				
MSW-7118P	7.0 kg	3.6kg	320W	125W	735*430*845	H:55 M:46 L:36	18.0kg	—