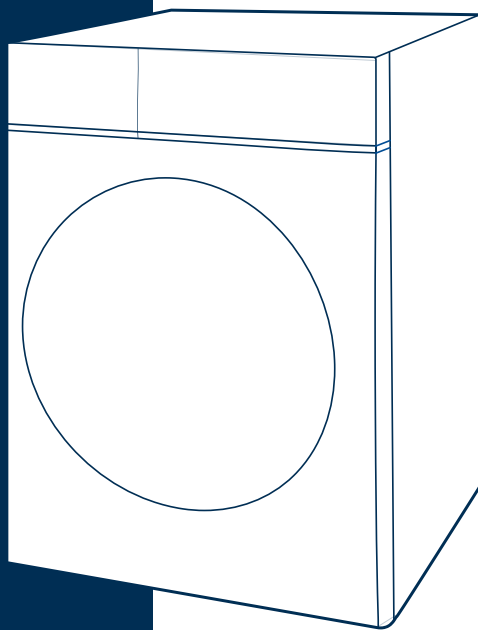

WASHING MACHINE**Front Loading****USER MANUAL****Read This Manual**

Read all instructions and explanations for the installation before use. Follow the instructions carefully. Keep the operation instructions handy for later use. If the appliance is sold or passed on, ensure that the new owner always receives this operation instructions.

**MODEL: MF200W85B Series
MF200W95B Series**

CONTENTS

SAFETY INSTRUCTIONS

- Safety Instructions 2

INSTALLATION

- Product Description 9
- Installation 10

OPERATION

- Quick Start 13
- Before Each Washing 15
- Detergent Dispenser 16
- Control Panel 18
- Programmes.....19
- Option..... 21

MAINTENANCE

- Cleaning and Care 24
- Trouble Shooting 28
- Technical Specifications 29

SAFETY INSTRUCTIONS

■ Safety Instructions

Please read the following safety information thoroughly and follow it strictly to minimize the risk of fire or explosion, electric shock and to prevent property damage, personal injury or loss of life. Failing to follow these instructions shall void any warranty.

Warning!

This combination of symbol and signal word indicates a potentially dangerous situation which may result in death or serious injuries unless it's avoided.

Caution!

This combination of symbol and signal word indicates a potentially dangerous situation which may result in slight or minor injuries or damage to property and the environment.

Note!

This combination of symbol and signal word indicates a potentially dangerous situation which may result in slight or minor injuries.

Warning!

ELECTRIC SHOCK HAZARD

- If the supply cord is damaged, it must be replaced by the manufacturer, its service agent or similarly qualified persons in order to avoid a hazard.
 - If the machine is damaged, it must not be operated unless repaired by the manufacturer, its service agent or similarly qualified persons.
- Risk of electric shock!

SAFETY INSTRUCTIONS

- The appliance can be used by children aged from 8 years and above and persons with reduced physical, sensory or mental capabilities or lack of experience and knowledge if they have been given supervision or instruction concerning use of the appliance in a safe way and understand the hazards involved. Children shall not play with the appliance. Cleaning and user maintenance shall not be made by children without supervision.
- Children should be supervised that they do not play with the appliance.
- Children 3 years and under shall be kept away from the appliance or continuously supervised.
- Animals and children may climb into the machine. Check the machine before every operation.
- Do not climb or sit on the appliance.

INSTALLATION LOCATION AND SURROUNDING

- All washing and additional substances are to be kept in a safe place out of the reach of children.
- Do not install the machine on a carpet floor. The obstruction of the openings by a carpet can damage the machine.
- Keep the appliance clear from heating sources and direct sunlight to avoid plastic and rubber parts to corrode.
- Do not use the appliance in humid environments or rooms containing explosive or caustic gas. In case of water leakage or water splashes let the appliance dry in the open air.
- The appliance must not be installed behind a lockable door, a sliding door or a door with a hinge on the opposite side to that of the washing machine.

SAFETY INSTRUCTIONS

- Do not operate the machine in rooms with a temperature of below 5°C. This can cause damages to parts of it. If it is unavoidable, make sure to drain the water completely from the appliance after every use (see "Maintenance - Cleaning of drain pump filter") to avoid damages caused by frost.
- Never use flammable sprays or substances in the immediate proximity of the appliance.

INSTALLATION

- Remove all packaging material and transport bolts before using the appliance. Otherwise, serious damage may result.
- This appliance is equipped with a single inlet valve and can be connected to the cold water supply only.
- Mains plug must be accessible after installation.
- Before washing clothes for the first time, the product shall be operated once throughout all the procedures without any clothes inside.
- Before using the washing machine, the product shall be calibrated.
- Do not put any excessively heavy objects on the appliance, like water containers or heating devices.
- The new hose-sets supplied with the appliance are to be used and that old hose-sets should not be reused.
- Max. Inlet water pressure 1 MPa. Min. inlet water pressure 0.05 MPa.

ELECTRICAL CONNECTION

- Make sure the supply cable is not trapped by the machine, it can get damaged.
- Connect the product to a grounded outlet protected by a fuse complying with the values in the "Technical specifications" table. The grounding installation has to be made by a qualified electrician. Ensure that the machine is installed in accordance with the local regulations.

SAFETY INSTRUCTIONS

•Water and electrical connections must be carried out by a qualified technician in accordance with the manufacturer's instructions and local safety regulations.

Warning!

- Don't use multiple plugs or extension cords.
- The appliance must not have an external switching device such as a timer or connected to a circuit that is regularly switched on and off.
- Do not pull the plug out of the mains outlet if there is flammable gas around.
- Never pull out power plug with wet hands.
- Always pull at the plug, not at the cable.
- Always unplug the appliance if it is not being used.

WATER CONNECTIONS

- Check the connections of the water inlet tubes, the water tap and the outlet hose for possible problems due to changes of water pressure. If the connections loosen or leak close the water tap and get it repaired. Do not use the appliance before the pipes and hoses are installed properly by qualified persons.
- Glass door may become very hot during the operation. Keep children and pets far away from the machine while it is operating.
- The water inlet and outlet hoses have to be safely installed and remain undamaged. Otherwise, water leakage can occur.
- Do not remove the drain pump filter while there is still water in the appliance. Big quantities of water can leak out, and there is a risk of scalding due to hot water.

SAFETY INSTRUCTIONS

OPERATION AND MAINTENANCE

- Never use any flammable, explosive or toxic solvents. Do not use gasoline and alcohol etc. as detergents. Only select detergents that are suitable for machine washing.
- Make sure that all pockets are emptied. Sharp and rigid items such as coins, brooches, nails, screws, stones etc. may cause serious damages to this machine.
- Remove all objects from pockets such as lighters and matches before use the appliance.
- Thoroughly rinse items that have been washed by hand.
- Items that have been soiled with substances such as cooking oil, acetone, alcohol, petrol, kerosene, spot removers, turpentine, wax and wax removers should be washed in hot with an extra amount of detergent before being dried in the appliance.
- Items containing foam rubber (latex foam), shower caps, water proof textiles, rubber backed articles and clothes or pillows fitted with foam rubber pads should not be dried in the machine
- Fabric softeners or similar products should be used as recommended in their instructions.
- Never try to open the door forcefully. The door will unlock shortly after the end of a cycle.
- Please do not close the door with excessive force. If it is found difficult to close the door, please check if the clothes are properly inserted and distributed.

SAFETY INSTRUCTIONS

- Always unplug the appliance and close the water tap before cleaning and maintenance and after each use.
- Never pour water over the appliance for cleaning purpose. Risk of electric shock!
- Repairs shall only be carried out by the manufacturer, its service agent or similarly qualified persons in order to avoid a hazard. The producer will not be responsible for damages caused by the intervention of not authorized persons.

TRANSPORT

- Before Transport:
 - Bolts shall be reinstalled to the machine by a specialized person
 - Accumulated water shall be drained out of the machine
- This appliance is heavy. Transport with care. Never hold any protruding part of the machine when lifting. The machine door cannot be used as a handle.

INTENDED USE

The product is intended only for home use and for textiles in household amounts suitable for machine washing and drying. This appliance is for indoor use only and not intended for built in use. Only use according to these instructions. The appliance is not intended for commercial use.

Any other use is considered as improper use. The producer is not responsible for any damage or injuries that may result of it.

- This appliance is intended to be used in household and similar applications such as:
 - Staff kitchen areas in shops, offices and other working environments;
 - Farm houses;
 - By clients in hotels, motels and other residential type environments;
 - Bed and breakfast type environments;
 - Areas for communal use in blocks of flats or in launderettes.

SAFETY INSTRUCTIONS

Packaging/Old appliance



This marking indicates that this product should not be disposed with other household wastes throughout the EU. To prevent possible harm to the environment or human health from uncontrolled waste disposal, recycle it responsibly to promote the sustainable reuse of material resources. To return your used device, please use the collection systems or contact the retailer where the product was purchased. They return and can take this product for environmental safe recycling.

INSTALLATION

■ Product Description

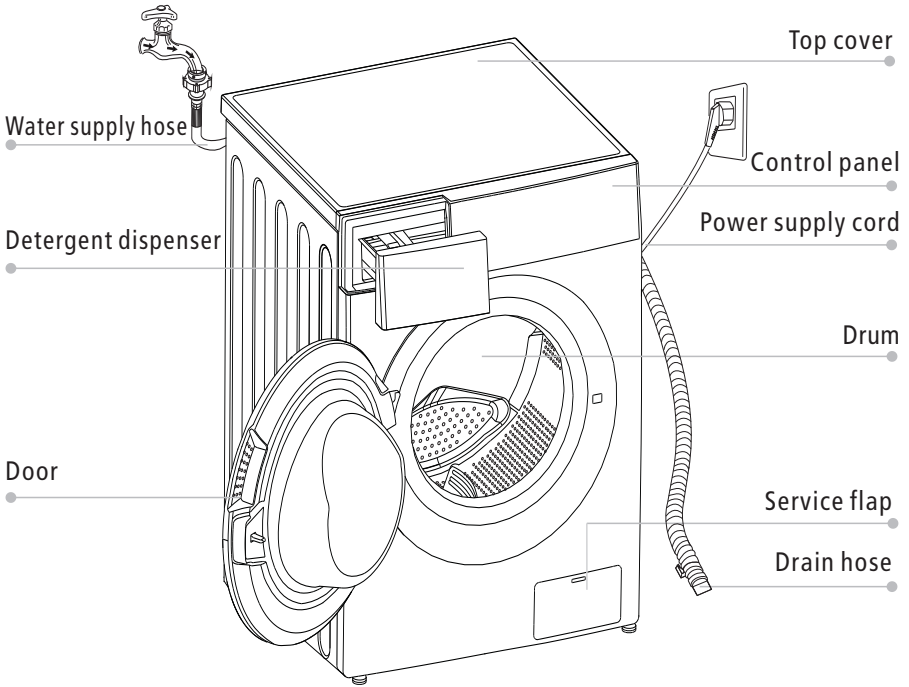

Note!

- The product picture is for illustration only, please refer to real product as reference.

Accessories

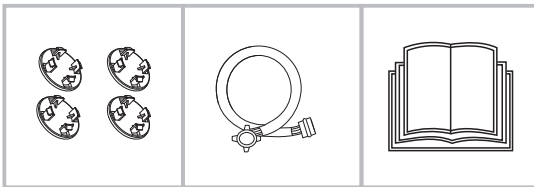

4 x Cover caps

1 x Supply hose
cold water

1 x Owner's manual

INSTALLATION

■ Installation

Installation area

⚠ Warning!

- Stability is important to prevent the product from wandering! Make sure the machine is standing leveled and stable.
- Make sure that the product does not stand onto the power cord.
- Make sure to maintain the minimum distances from the walls as shown in the picture

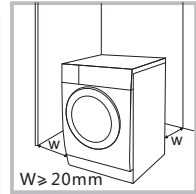

Before installing the machine, the location characterized as follows shall be selected:

1. Rigid, dry, and level surface
2. Avoid direct sunlight
3. Sufficient ventilation
4. Room temperature is above 0°C
5. Keep far away from the heat sources such as coal or gas burning appliances.

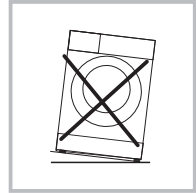

Unpacking the washing machine

⚠ Warning!

- Packaging material (e.g. Films, Styrofoam) can be dangerous for children.
- There is a risk of suffocation ! Keep all packaging well away from children.

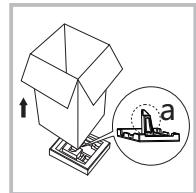

1. Remove the cardboard box and styrofoam packing.
2. Lift the washing machine and remove the base packaging. Make sure the small triangle foam (a) is removed with the bottom packaging together. If not, lay the unit down on the side surface and remove it manually.
3. Remove the tape securing the power supply cord and drain hose.
4. Remove the inlet hose from the drum.

INSTALLATION

Remove transport bolts

⚠ Warning!

- You must remove the transport bolts from the backside before using the product.



Loosen the 4 transport bolts with a spanner.

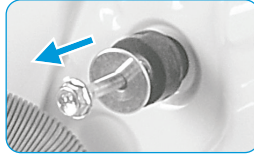

Remove the bolts including the rubber parts and keep them for future use.

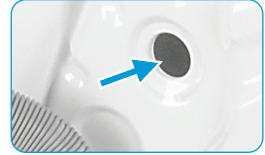

Close the holes using the cover caps.

Levelling the washing machine

⚠ Warning!

- The lock nuts on all four feet must be screwed tightly against the housing.

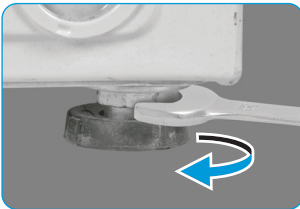

1. Loosen the lock nut.
2. Turn the foot until it reaches the floor.
3. Adjust the legs and lock the nuts with a spanner. Make sure the machine is level and steady.

Connect the water supply hose

⚠ Warning!

To prevent leakage or water damage, follow the instructions in this chapter

- Do not kink, crush or modify water inlet hose.



Connect the water supply hose to the water inlet valve and a water tap with cold water as indicated.



🔧 Note!

- Connect manually, do not use tools. Check if the connections are tight.

INSTALLATION

Drain Hose

⚠ Warning!

- Do not kink or protract the drain hose.
- Position drain hose properly ,otherwise damage might result of water leakage.

There are two ways to place the end of drain hose:

1.Put it into the water trough.

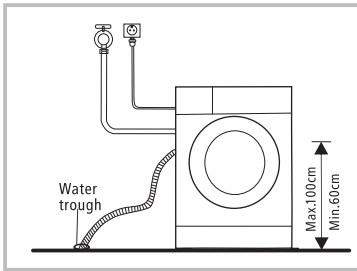

2.Connect it to the branch drain pipe of the trough.

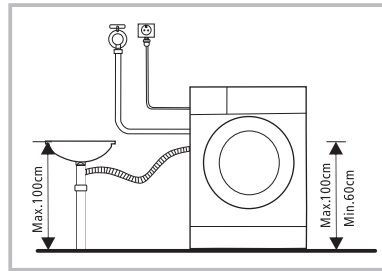

OPERATION

■ Quick Start

⚠ Caution!

- Before washing, please make sure the washing machine is installed properly.
- Your appliance was thoroughly checked before it left the factory. To remove any residual water and to neutralize potential odors, it's recommended to clean your appliance before first use. For this reason, start the Cotton program at 90°C without laundry and detergent.

📌 Calibration

It's recommended to calibrate the washing machine, so that provide the best performance.

The appliance is able to detect the amount of laundry loaded. This function is optimizing the product performance by minimizing energy and water consumption, saving you money and time. For this reason it's recommended to calibrate the appliance for best use.

- 1- Remove all accessories from the drum and close the door;
- 2- Insert the mains plug to the socket;
- 3- Switch on the washing machine and press "Turbo" and "Extra Rinse" simultaneously for 10 seconds until "t19" is displayed;
- 4- Press [▷||] to start the appliance and wait till "*****" is displayed.

OPERATION

1. Before Washing

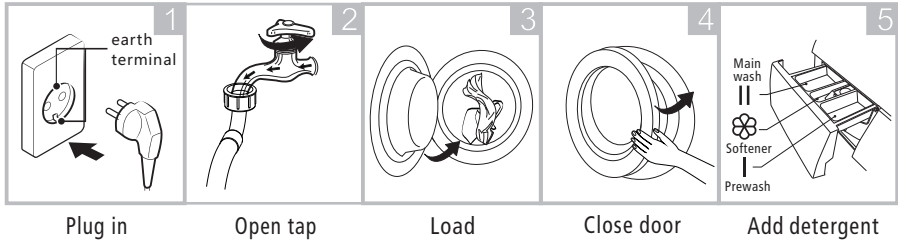

Note!

- Detergent need to be added in compartment I if the pre-wash function is selected.

2. Washing

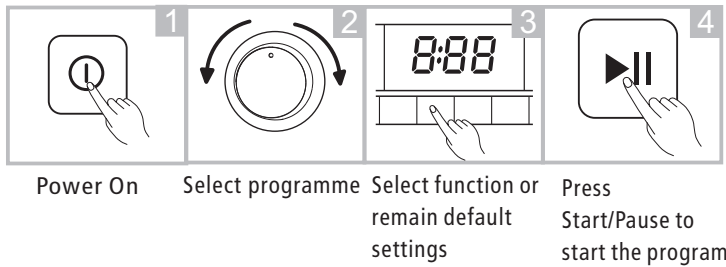

3. After Washing

Buzzer beep and "End" on display.

OPERATION

■ Before Each Washing

- The ambient temperature of the washing machine should be 5-40°C. If used under 0°C, the inlet valve and draining system may be damaged. If the machine is installed under freezing conditions, it should be transferred to normal ambient temperature to ensure the water supply hose and drain hose can unfreeze before use.
- Please check your laundry care labels and the detergent use instructions before wash. Use non-foaming or less-foaming detergent suitable for machine washing properly.

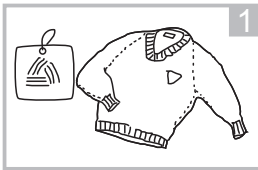

Check the care label

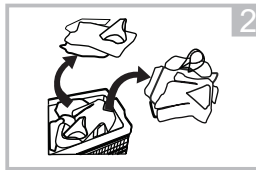

Sort laundry according to color and textile type

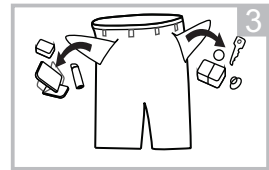

Take all items out of the pockets

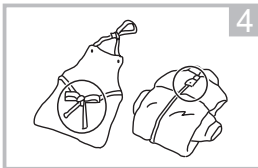

Tie together long textile strips and belts, close zips and button

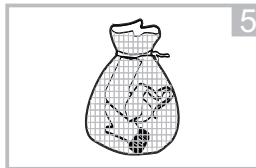

Put small items into a laundry bag

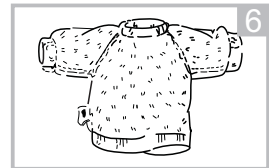

Turn easy-pilling and long-pile fabric inside out

⚠ Warning!

- Do not wash or dry articles that have been cleaned in, washed in, soaked in, or dabbed with combustible or explosive substances like wax, oil, paint, gasoline, alcohol, kerosene, and other flammable materials.
- Washing single clothes items may easily create big eccentricity and cause alarm due to unbalance. Therefore it is suggested to add one or two more laundry items to the wash so that spin can be done smoothly.

OPERATION

■ Detergent Dispenser

- I Pre wash
- II Main wash
- ☼ Softener
- ⊖ Release button to pull out the dispenser

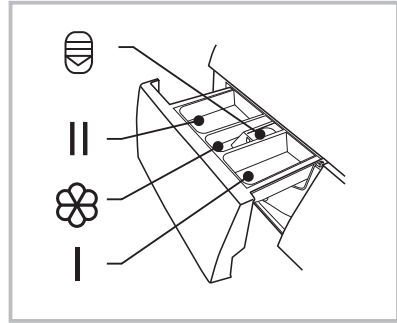

⚠ Caution!

- Detergent only need to be added in "compartment I "after selecting pre-wash function.

Programme	I	II / ⊖	☼	Programme	I	II / ⊖	☼
Cotton	○	●	○	Rapid 45'	○	●	○
Mix	○	●	○	ECO 40-60		●	○
Synthetic	○	●	○	Bulky	○	●	○
Jeans	○	●	○	Wool		●	○
Cold Wash		●	○	Rinse & Spin			○
Allergy Care	○	●	○	Spin Only			
Steam Care	○	●	○	Drum Clean			
Quick 15'		●	○				

● Means must ○ Means optional

OPERATION

Detergent Recommendation

Recommended washing detergent	Wash cycles	Washing temp.	Type of laundry and textile
Heavy-duty detergent with bleaching agents and optical brighteners	Cotton, ECO 40-60, Mix, Bulky	20/30/ 40/60	White laundry made from boil-proof cotton or linen
Colour detergent without bleaching agent and optical brighteners	Cotton, ECO40-60, Mix, Bulky, Cold Wash	Cold/20/ 30/40	Coloured laundry made from cotton or linen
Color or mild detergent without optical brighteners	Cold Wash, Synthetic	Cold/20/ 30/40	Coloured laundry made from easy care fibres or synthetic materials
Mild washing detergent	Synthetic	20 /30	Delicate textiles, silk, viscose
Special wool detergent	Wool	20/30	Wool

Note!

- Agglomerating or ropy detergent or additive can be diluted in some water before pouring it into the detergent dispenser, to avoid its inlet to get blocked and thus cause a water overflow.
- Please choose the suitable type of detergent to get a maximum of washing performance and a minimum of water and energy consumption
- To achieve the best cleaning result a proper detergent dosing is important.
- Use a reduced detergent amount if the drum is not filled completely.
- Always adjust the amount of detergent to the water hardness, if your tap water is soft, use less detergent.
- Dose according to how dirty your laundry is, less dirty clothes require less detergent.
- Highly concentrated (compact detergent) requires particularly accurate dosing.

Following symptoms are a sign of detergent overdosing:

- heavy foam formation
- poor washing and rinsing result

Following symptoms are a sign of detergent underdosing:

- laundry turns grey
- built-up of limescale deposits on the drum, the heating element and/or the laundry

OPERATION

■ Control Panel

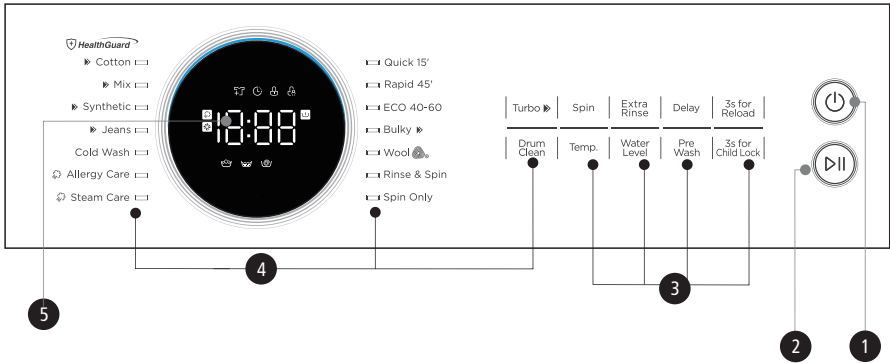

1 On/Off
Turn the appliance on and off.

2 Start/Pause
Start or pause your programme.

3 Option
This allows you to select additional functions and will light when selected.

4 Programmes
Available according to the laundry type.

5 Display
The display shows settings, estimated remaining time, options and status messages.

The diagram shows the control panel with the following elements and callouts:

- A:** Display area.
- B:** Reload button (crown icon).
- C:** Delay button (clock icon).
- D:** Door Lock button (lock icon).
- E:** Child Lock button (child icon).
- F:** SteamCare button (steam icon).
- G:** AutoClean button (crown icon).
- H:** Pre Wash button (crown icon).
- I:** Wash button (crown icon).
- J:** Rinse button (crown icon).
- K:** Spin button (crown icon).

A Display	
Wash Time	Delay Time
125	2h
Speed	Error
400	E30
End	Temp.
End	30

B Reload	C Delay
D Door Lock	E Child Lock
F SteamCare	G AutoClean
H Pre Wash	I Wash
J Rinse	K Spin

OPERATION

■ Programmes

Programme	Load(kg)		Display Time	
	8.5	9.5	8.5	9.5
Cotton	8.5	9.5	3:49	3:49
Mix	8.5	9.5	1:30	1:30
Synthetic	4.0	4.5	3:27	3:27
Jeans	8.5	9.5	1:56	1:56
Cold Wash	4.0	4.5	0:58	0:58
Allergy Care	4.0	4.5	2:38	2:38
Steam Care	4.0	4.5	1:57	1:57
Quick 15'	2.0	2.0	0:15	0:15
Rapid 45'	2.0	2.0	0:45	0:45
ECO 40-60	8.5	9.5	3:35	3:41
Bulky	8.5	9.5	1:48	1:48
Wool	2.0	2.0	1:07	1:07
Rinse & Spin	8.5	9.5	0:30	0:30
Spin Only	8.5	9.5	0:12	0:12
Drum Clean	-	-	1:18	1:18



Note!

- The parameters in this table are only for user's reference. The actual parameters maybe different with the parameters in above mentioned table.

OPERATION

■ Programmes

Programmes are available according to the laundry type.

Programmes	
Cotton	Hard-wearing textiles, heat-resistant textiles made of cotton or linen.
Mix	Mixed load consisting of textiles made of cotton and synthetics.
Synthetic	Wash synthetic articles, for example: shirts, coats, blending. While washing the knitting textiles, detergent quantity shall be reduced due to its loose string construction and easily forming bubbles.
Jeans	Specially for jeans.
Cold Wash	Washing brightly colored clothes, it can protect the colors better.
Allergy Care	This program applies 60°C high temperature sterilization to make the clothes washing more clean to achieve the anti-allergy effect.
Steam Care	Steam Care is applicable for daily laundries like cotton and synthetics. The steam can deeply penetrate the fiber, which effectively eliminate bacterias and germs, preventing odors and protecting your health.
Quick 15'	Extra short programme approx, suitable for lightly soiled washing as a small amounts of laundry.
Rapid 45'	This programme is suitable for washing not very dirty clothes, save more energy and washing.
ECO 40-60	Default 40°C, not selectable, suitable for laundry washing at about 40°C-60°C.
Bulky	This program is specially designed for washing duvet coats.
Wool	Hand or machine-washable wool or richwool textiles. Especially gentle wash programme to prevent shrinkage, longer programme pauses (textiles rest in wash liquor).
Rinse&Spin	Extra rinse with spin.
Spin Only	Extra spin with selectable spin speed.
Drum Clean	Specially set in this machine to clean the drum and tube. It applies 90 °C high temperature sterilization to make the clothes washing more green. When this programme is performed, the clothes or other washing cannot be added. When proper amount of chlorine bleaching agent is put in, the barrel cleaning effect will be better. The customer can use this programme regularly according to the need.

OPERATION

Options

Cycle	Default Temp.(°C)	Default spin speed in rpm	Additional functions
Wash cycles		1400	
Quick 15'	Cold	800	🕒
Rapid 45'	40	800	🕒, 📏, 🏠
ECO 40-60	--	1400	🕒
Bulky	40	1000	🕒, 📏, 🏠, ▶▶
Wool	40	600	🕒, 🏠
Rinse & Spin	--	1000	🕒, 🏠, 🌸
Spin Only	--	1000	🕒
Steam Care	40	800	🕒, 📏, 🏠, 🌸, 🌀
Allergy Care	60	800	🕒, 📏, 🏠, 🌸, 🌀
Cold Wash	Cold	800	🕒, 🏠
Jeans	60	1000	🕒, 📏, 🏠, ▶▶, 🌸
Synthetic	40	1200	🕒, 📏, 🏠, ▶▶, 🌸
Mix	40	800	🕒, 📏, 🏠, ▶▶, 🌸
Cotton	40	1400	🕒, 📏, 🏠, ▶▶, 🌸
Drum Clean	90	--	🕒, 🏠

Note!

- For the maximum spin speed, program time, and other details of the ECO 40-60 program, please refer to the content on the Product Fiche page.
- The table shows which cycle offers which options for adjustment. If an adjustment is not possible for a cycle.

Temp.

Temp.

When needed, the washing temperature can be adjusted by pressing the temperature button in the following steps: Cold - 20°C - 30°C - 40°C - 60°C - 90°C.

OPERATION

Speed

Spin Speed

When needed, the spinning speed can be adjusted pressing the Speed button in the following steps: 1400: 0-400-600-800-1000-1200-1400

Delay

Delay

1. Select a programme
2. Press the Delay button to choose the delaying time 0-24h
3. Press [Start/Pause] to start the delay operation



Choose programme



Setting time



Start

To cancel the Delay function, press the "Delay" button before starting the program until the display shows 0 h. If the program has already started, switch the appliance off and afterwards on and select a new programme.



Pre Wash

Extra washing function before the main washing cycle starts to increase the washing performance.

Note: Detergent needs to be added to the compartment I.



Extra Rinse

The laundry will undergo an extra rinse after selecting this function.

Turbo ▶▶

Turbo

The function can decrease the washing time.

3s for Reload

Reload

This operation can be executed during the washing progress. When the drum is still rolling and there is large amount of water with high temperature in the drum. The state is unsafe and the door cannot be opened forcefully. To Press [3s for Reload]3sec. to reload, and start the clothes adding in the midway function. Please follow the steps as bellow:

- 1.Wait until the drum stops rotation.
- 2.The door lock is unlocked.
- 3.Close the door when the clothes are reloaded and press the [Start/Pause] button.



Press[3s for Reload]3sec.



Reload the clothes



Start

OPERATION



Child Lock

This function is meant to keep children from misusing the controls.



Press [3s for Child Lock] simultaneously for 3 sec until the buzzer beep. The child lock indicator switches on.



⚠ Caution!

When the Child Lock is activated, the display will alternately show "CL" and the remaining time.

Pressing any other button will cause the Child Lock indicator to flash for 3 sec.

When the program ends, "CL" and "END" will alternate on the display for 10 sec, then the indicator will flash for 3 sec.

The Child Lock deactivates the function of all buttons except the On/Off button and the Child lock button!

Only the simultaneous pressing of the button [3s for Child Lock] can deactivate the Child Lock!

Please deactivate the Child Lock before selecting a new program!



AutoClean

The self-clean function will be automatically activated during every washing cycle. Hygiene Pro system will keep your laundry always clean. Environmentally save time and ease your laundry.



Water Level

Press the button to change the water level : AU/L-1/L-2/L-3/L-4



SteamCare

SteamCare is the function added before main wash, which will generate warm steam to sterilization and greater washing performance especially for cold wash.

⚠ Caution!

Some programs have automatically added AutoClean or SteamCare functions, these two functions can't be manually selected or canceled.

MAINTENANCE

■ Cleaning and Care

⚠ Warning!

- Always unplug the appliance and close the water tap before cleaning and maintenance.

Cleaning the Cabinet

Proper maintenance on the washing machine can extend its working life. The surface can be cleaned with diluted non-abrasive neutral detergents when necessary. If there is any water overflow, use a cloth to wipe it off immediately. Never use sharp items to clean the appliance.

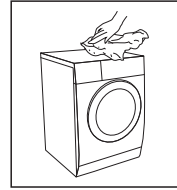

⚠ Caution!

- Never use abrasive or caustic agents, formic acids or its diluted solvents or similar substances, like alcohol or chemical products.

Cleaning the Drum

Any rust stains left inside the drum by metal articles must be removed immediately using chlorine-free detergents. Never use steel wool for cleaning the drum!

📌 Note!

- Keep any laundry away from the machine while cleaning the drum.

Cleaning the Door Seal and Glass

Wipe the glass and seal after each wash to remove lint and stains. If lint builds up it can cause leakages.

Remove any coins, buttons and other objects from the seal after each wash.

Clean the Door Seal and Glass every month to ensure the normal operation of the appliance.

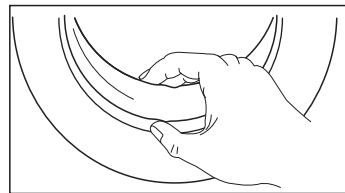

MAINTENANCE

Cleaning the Inlet Filter

Note!

- Diminishing water flow is a sign that the filter need to be cleaned.

1. Close the tap and remove the water supply hose from it.
2. Clean the filter with a brush.
3. Unscrew the water supply hose from the backside of the machine. Pull out the filter with long nose pliers.
4. Use a brush to clean the filter.
5. Reinstall the filter to the water inlet and reconnect the water supply hose.
6. Clean the Inlet filter every 3 months to ensure the normal operation of the appliance.

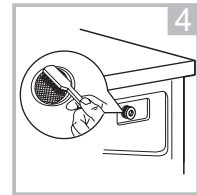
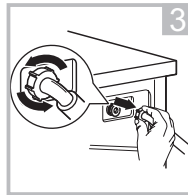
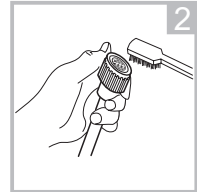
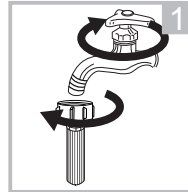

Clean The Detergent Dispenser

1. Press down the release [] on the softener cover and pull the dispenser drawer out of the recess. Clean the inside of the recess with a brush.
2. Lift the softener cover off the dispenser drawer and wash both items with water.
3. Restore the softener cover and push the drawer back into the recess.

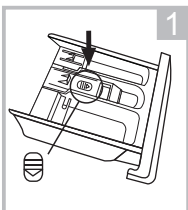

Press the release and remove the dispenser drawer

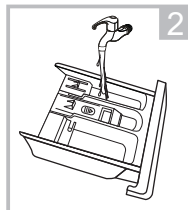

Clean the dispenser drawer and the softener cover under water

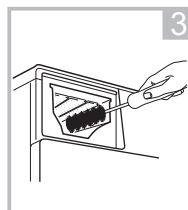

Clean the recess with an soft brush

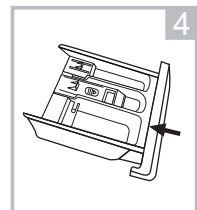

Insert the dispenser drawer

Note!

- Do not use abrasive or caustic agents to clean plastic parts.
- Clean the detergent dispenser every 3 months to ensure the normal operation of the appliance.

MAINTENANCE

Cleaning the Drain Pump Filter

⚠ Warning!

- Make sure that the machine has finished the washing cycle and is empty. Switch it off and unplug it before cleaning the drain pump filter.
- Be careful of hot water. Allow the water to cool down. Risk of scalding!
- Clean the filter periodically every 3 months to ensure the normal operation of the appliance.

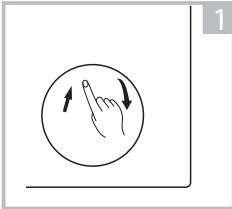

Open the lower cover cap

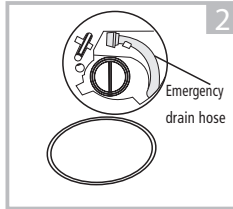

Pull out the emergency drain hose, and take off the hose cap

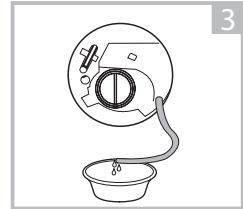

After water runs out, reset the drain hose

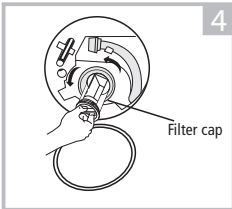

Open the filter by turning to the counter clockwise

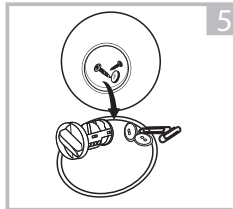

Remove extraneous matter

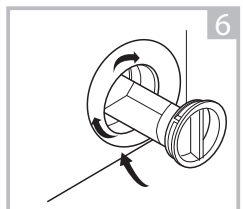

Close the lower cover cap

⚠ Caution!

- Make sure emergency drain hose cap and the emergency drain hose are reinstalled properly, otherwise water may leak.

MAINTENANCE

Emergency Door Release

In case of power failure or other circumstances and door cannot be opened. If it is necessary to open the door under this circumstances, please pull down the pull cord inside emergency door and restore the pull cord after opening the door.

Emergency door pull cord

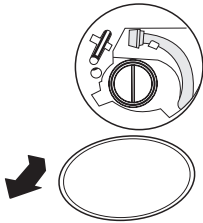

1. Open filter door

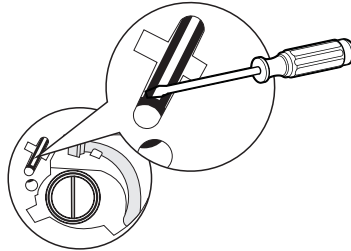

2. Using a straight screwdriver (or other non-sharp tool), insert into the emergency door pull cord

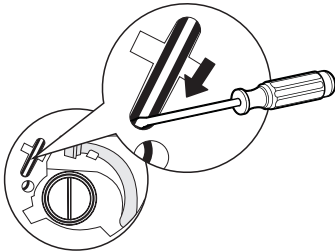

3. Pull down the emergency door pull cord (refer to direction of the arrow in the picture). If unlocked successfully, you will find the door lock icon will go out.

Warning!

The machine is not allowed to use the emergency switch pull cord during washing. If need to run machine urgently, it is recommended to open door after water is cooled, to avoid getting burn caused by high temperature residual water outflow from the machine tub.

MAINTENANCE

■ Trouble Shooting

Whenever there is a problem with the appliance, check if you can solve it following the tables below. If the problem persists, please contact the customer service.

Description	Possible cause	Solution
Appliance does not start	Door is not closed properly. Clothes are stuck.	Close the door properly and restart. Check the laundry.
Door can't be opened	Safety protection is activated.	Disconnect the power and restart.
Water leakage	Connections are not tight enough.	Check and fasten the water inlet pipe. Check and clean the outlet hose.
Detergent residues in the detergent dispenser	Detergent is damp and/or clotted.	Clean and wipe the detergent dispenser dry.
Indicator or display does not work	PC board or harness have connection problems.	Switch off the power and check if the mains plug is connected properly.
Abnormal noise	Fixing bolts still in place. Floor is not solid or level.	Check if the fixing bolts have been removed Make sure the appliance is installed on a solid and level floor.

Error Codes

Description	Possible cause	Solution
E30	Door is not closed properly	Close the door properly and restart.
E10	Water injecting problem during wash cycle.	Check if the water pressure is high enough. Straighten the water pipe. Clean the inlet valve filter.
E21	Overtime water draining	Check the drain hose for blockage.
E12	Water overflow	Restart the appliance.
EXX	Others	Restart the appliance. If problem persists, please contact the customer service.

MAINTENANCE

■ Customer service

Spare part for your appliance are available for a minimum of 10 years.

In case of questions please contact our customer service at:

⚠ Warning!

Risk of electric shock

- Never try repair an appliance which is defective or presumed to be defective. You may put your own and future users' lives in danger. Only authorised specialists are allowed to carry out this repair work.
- Improper repair will void the warranty and subsequent damages can't be recognized!

Transport

IMPORTANT STEPS WHEN MOVING THE APPLIANCE

- Unplug the appliance and close the water inlet tap.
- Check, if the door and the detergent dispenser are closed properly.
- Remove the water inlet pipe and the outlet hose from the house installations.
- Let the water drain completely from the appliance (see "Maintenance Cleaning the drain pump filter")
- Important: Re-install the 4 transport bolts in the back of the appliance.
- This appliance is heavy. Transport with care. Never hold any protruding part of the machine when lifting. The machine door cannot be used as a handle.

■ Technical Specifications

Power Supply 220-240V~,50Hz

MAX.Current 10A

Standard Water Pressure 0.05MPa~1MPa

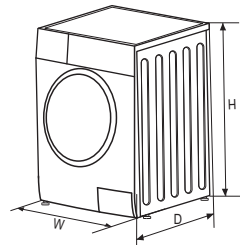

Model	Washing Capacity	Dimension (W*D*Hmm)	Net Weight	Rated Power
MF200W85B Series	8.5kg	595*475*850	63kg	1950W
MF200W95B Series	9.5kg	595*565*850	71kg	2000W



QUESTIONS OR COMMENTS

Country	Contact Center	Web Site
Thailand	+6621077799	http://www.midea.com/th
Myanmar	+09260367229	https://www.gbs.com.mm/en/about/vsk/
Cambodia	+85523212435	http://bluemidea.com
Vietnam	+1800588863	http://vn.midea.com
Philippines	+63288635522	http://www.mideaph.com
Indonesian	+628001888523	http://id.midea.com
Malaysia	+60392211033	https://www.midea.com/my/
Singapore	+62222536	https://www.midea.com/sg/

This product is RoHS compliant.



make yourself at home

V1.0
16238000A *****