

TUMBLE DRYER**USER MANUAL****Dryer****Read This Manual**

Read all instructions and explanations before use. Follow the instructions carefully. Keep the operation instructions handy for later use. If the appliance is sold or passed on then ensure that the new owner always receives these operation instructions.

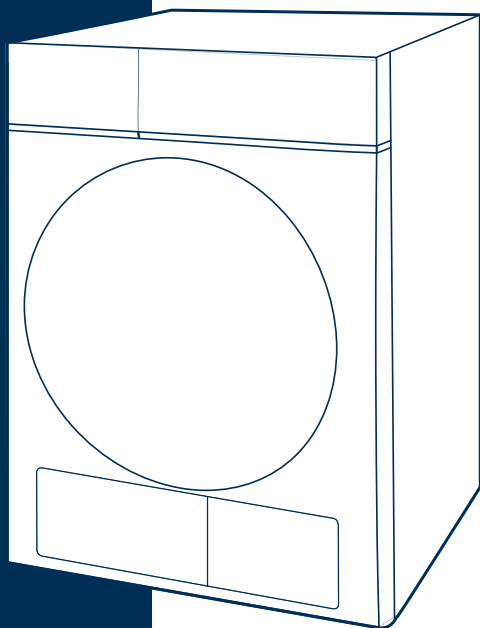

**MODEL: MD200H100W
MD200H100WT**

CONTENTS

SAFETY INSTRUCTIONS

- Safety Instructions 2

INSTALLATION

- Product Description 11
- Installation 11

OPERATION

- Quick Start 14
- Before Each Drying 15
- Control Panel 17
- Option..... 18
- Display..... 21
- Programmes..... 22
- Drying Programmes Table 23
- Consumption Data..... 24
- App Setup And Operation..... 25

MAINTENANCE

- Cleaning and Care 27
- Trouble Shooting 30
- Technical Specifications 32



DANGER

This symbol indicates that there are dangers to the life and health of persons due to extremely flammable gas.

SAFETY INSTRUCTIONS

■ Safety Instructions



CAUTION: RISK OF FIRE !



WARNING!

To prevent any damages to your and others' life or property, you have to follow the safety notes.

Intended use

- This heat pump dryer is intended for drying typical amounts of household laundry, which have been washed with water. It has been designed solely for private use and is not suitable for commercial or shared use (i.e. by several families in an apartment building).
- Use this appliance only as described in this user manual.
- This appliance is for indoor use only.
- Any other use is deemed improper and may result in damage to property or even personal injury.
- The manufacturer accepts no liability for damage caused by improper use.

Safety Instructions

- The appliance corresponds to protection class I and may only be connected to a plug with a protective conductor that has been installed properly. When connecting the appliance to the mains, make sure that the mains voltage is correct. You can find more information about this on the rating plate.

SAFETY INSTRUCTIONS

WARNING!

Electric shock hazard

- Before connecting the tumble dryer, ensure that the connection parameter on the rating plate (fuse rating, voltage and frequency) match the mains electricity supply. If in any doubt, consult a qualified electrician.
- The electrical safety of this tumble dryer can only be guaranteed when correctly earthed. It is essential that this standard safety requirement is met. If in any doubt, please have the household wiring system tested by a qualified electrician. The manufacturer cannot be held liable for the consequences of an inadequate earthing system (e.g. electric shock).
- Do not pull the power cord forcefully. Please grasp the mains plug instead
- Do not plug/draw the mains plug with wet hands.
- Do not bend, clamp or damage the power cord and the power plug.
- If the power cable is damaged, it must be replaced by the manufacturer, its service agent or similarly qualified persons in order to avoid a hazard.

SAFETY INSTRUCTIONS

- **WARNING:** The appliance must not be supplied through an external switching device, such as a timer, or connected to a circuit that is regularly switched on and off by a utility.
- Do not connect the appliance to the mains electricity supply by an extension lead, multi-socket adapter or similar.
- The accessibility of the plug must always be ensured, in order to disconnect the tumble dryer from the mains.
- If the appliance appear high temperature abnormally, please draw the mail plug immediately.

Injury danger

- The appliance must not be installed behind a lockable door, a sliding door or a door with a hinge on the opposite side to that of the tumble dryer, in such a way that a full opening of the tumble dryer door is restricted.
- Do not disassemble or install the dryer without any instruction or supervision.
- Do not stack this dryer on washing machine without stacking kits. (If you want to stack this dryer on a washing machine, please purchase the independent parts. Installation shall be done by the manufacturer, its service agent or similarly qualified persons to avoid any hazards.)
- Do not lean on the opened door of the dryer.
- Condensed water is not drinking water. It can cause health problems in both people and animals if consumed.

Damage danger

- Do not put more load than rated in this user manual. See the related chapter in the user manual.

SAFETY INSTRUCTIONS

- Do not operate the dryer without the door filter.
- Do not dry the clothes before being spun.
- Do not expose the dryer directly under the sun.
- Do not install the dryer in humid and drenching environment.
- While cleaning and maintenance, please do remember to pull out the power plug and do not directly spray the dryer with water.
- The appliance should not be overturned during normal use or maintenance.



CAUTION: RISK OF FIRE !

Explosion & Fire danger

- Please do not dry the clothes with any flammable substances such as kerosene or alcohol. Otherwise, there may be explosion.
- The appliance contains an environmentally friendly but flammable R290 refrigerant. Keep away from open flame and other sources of ignition.
- The tumble dryer is not to be used if industrial chemicals have been used for cleaning.
- Do not dry unwashed items in the tumble dryer.
- Items that have been soiled with substances such as cooking oil, acetone, alcohol, petrol, kerosene, spot removers, turpentine, waxes and wax removers should be washed in hot water with an extra amount of detergent before being dried in the tumble dryer.

SAFETY INSTRUCTIONS

- Items such as foam rubber (latex foam), shower caps, waterproof textiles, rubber backed articles and clothes or pillows fitted with foam rubber pads should not be dried in the tumble dryer.
- Fabric softeners, or similar products, should be used as specified by the fabric softener instructions.
- Oil-affected items can ignite spontaneously, especially when exposed to heat sources such as in a tumble dryer. The items become warm, causing an oxidation reaction in the oil. Oxidation creates heat. If the heat cannot escape, the items can become hot enough to catch fire. Piling, stacking or storing oil-affected items can prevent heat from escaping and so create a fire hazard.
- Remove all objects from pockets such as lighters and matches.
- If it is unavoidable that fabrics that contain vegetable or cooking oil or have been contaminated by hair care products be placed in a tumble dryer they should first be washed in hot water with extra detergent. This will reduce, but not eliminate the hazard.
- **WARNING:** Never stop a tumble dryer before the end of the drying cycle unless all items are quickly removed and spread out so that the heat is dissipated.
- Openings must not be obstructed.
- The lint trap has to be cleaned frequently.
- Lint must not be allowed to accumulate around the tumble dryer.
- Do not damage the refrigerant circuit.

SAFETY INSTRUCTIONS

Safety with children

- This appliance can be used by children aged from 8 years and above and persons with reduced physical, sensory or mental capabilities or lack of experience and knowledge if they have been given supervision or instruction concerning use of the appliance in a safe way and understand the hazards involved. Children shall not play with the appliance. Cleaning and user maintenance shall not be done by children without supervision.
- Children should be supervised to ensure that they do not play with the appliance.
- Children of less than 3 years should be kept away unless continuously supervised.
- Always close the door after use. In this way you will avoid the danger of:
 1. Children climbing onto or into the dryer or hiding things in it.
 2. Pets or other small animals climbing into it.

SAFETY INSTRUCTIONS

UV Radiation Safety

- This warning only covers products which contain a UV-C lamp and which have a germs reduction function with UV-C lamp.
- The device contains a lamp that emits UV-C rays. Do not look at the source of light while the lamp is operating!
- UV-C Lamp is used to provide germs reduction in textile products.
- Do not take the UV-C Lamp out of the device and do not operate it outside!
- Do not touch the lamp!
- Use of the product except for its purpose or damage to the UV-C lamp protection glass or surrounding may cause dangerous UV-C radiation to occur. UV-C radiation can damage the eyes and skin even in low doses. Do not operate any product which is damaged!
- Do not remove the UV-C lamp protection glass. Do not operate the product without the UV-C lamp protection glass!
- After the appliance stops due to various reasons (power outage, fuse problem, machine door opening, etc.) while UV Hygiene Programs are in progress, the program will resume to germs reduction from where it left.

SAFETY INSTRUCTIONS

- In cases where UV-C lamp and related parts need to be replaced (expiration of lamp life, break of lamp glass, etc.), call the technical service. Do not try to replace the parts by yourself. When waiting for technical service, make sure the machine is closed and the plug is disconnected!
- Keep children away while using any programmes with activated UV-C Lamp!
- Always read the product guide before using the device and use the product according to the instructions!
- The placement of the UV Lamp and lamp protector glass in your product is visually indicated.
- Hygiene programme incorporating UV is effective for removing *Escherichia coli*, *Staphylococcus aureus* bacteria .

SAFETY INSTRUCTIONS

Correct Disposal of this product:



This marking indicates that this product should not be disposed with other household wastes throughout the EU. To prevent possible harm to the environment or human health from uncontrolled waste disposal, recycle it responsibly to promote the sustainable reuse of material resources. To return your used device, please use the return and collection systems or contact the retailer where the product was purchased. They can take this product for environmental safe recycling.

Disposal of packaging material

- The packaging is designed to protect the appliance from damage during transportation. The packaging materials are environmentally friendly and should be recycled. Recycling the packaging can reduce the use of raw materials in the manufacturing process and the amount of waste in landfill sites.

| Model | Rated capacity |
|---------------------------|----------------|
| MD200H100W MD200H100WT | 10.0kg |

INSTALLATION

■ Product Description

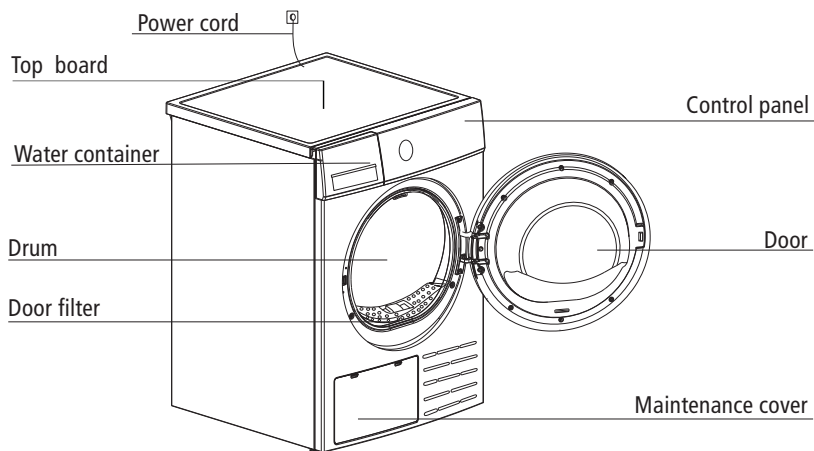

Note: The actual model you purchased might differ. Please see the product you purchased in kind prevail.

Accessories

The following parts are optional for specific models.

If your dryer has following parts, please wear gloves to install them as per the instruction below .

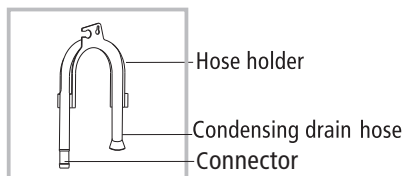

■ Installation

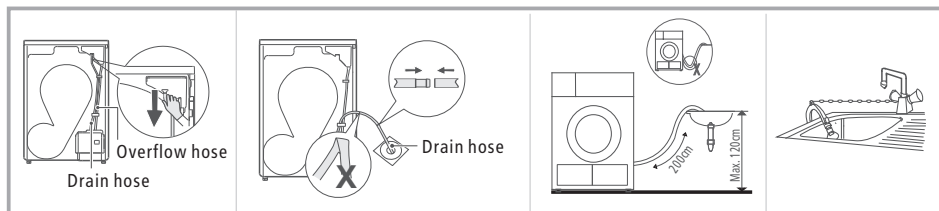

Pull out the upper drain hose

Put the external drain hose into the floor drain (be careful not to kink the external drain hose)

Put the hose holder in the washing basin or any other sink.

INSTALLATION

Transport

Move cautiously. Do not grasp any salient parts of machine. The machine door cannot be used as the handle for transport. If the dryer can't be transported erectly, the dryer can be tilted to right less than 30°.

Risk of injury and damage!

Improper handling of the appliance may result in injury.

- The appliance is very heavy. Never transport or carry the appliance alone; always with the assistance of another person.
- Remove all obstacles on the transport route and from the installation location, e.g. open doors and clear away objects lying on the floor.
- Do not use the open door as a handhold.
- Remove all package material before using the appliance.
- Before setting up the tumble dryer, check it for any externally visible damage. Do not install or use a damaged tumble dryer.
- Do not install the tumble dryer in a room where there is a risk of frost occurring. At temperatures around freezing point the tumble dryer may not be able to operate properly. There is a risk of damage if the condensed water is allowed to freeze in the pump and hoses.

Installation Position

WARNING!

- Children can become entangled in the packaging film or swallow small parts and suffocate. Do not allow children to play with the packaging.
 - The appliance must not be installed behind a lockable door, a sliding door or a door with a hinge on the opposite side to that of the tumble dryer, in such a way that a full opening of the tumble dryer door is restricted.
 - Do not restrict the floor clearance through deep pile carpets, strips of wood or similar. This might cause heat built-up which would interfere with the operation of the appliance.
1. It is recommended that, for your convenience, the machine is positioned close to your washing machine.
 2. Do not stack this dryer on washing machine without stacking kits. (If you want to stack this dryer on a washing machine, please purchase the independent parts. Installation shall be done by the manufacturer, its service agent or similarly qualified persons to avoid any hazards.)
 3. The tumble dryer must be installed in a clean place, where dirt does not accumulate. Air must be able to circulate freely around the appliance. Do not obstruct the front air inlet or the air intake grilles at the back of the machine.

INSTALLATION

4. To keep vibration and noise within minimum level when the dryer is in use, it must be placed on a firm and level surface.
5. The feet must never be removed.

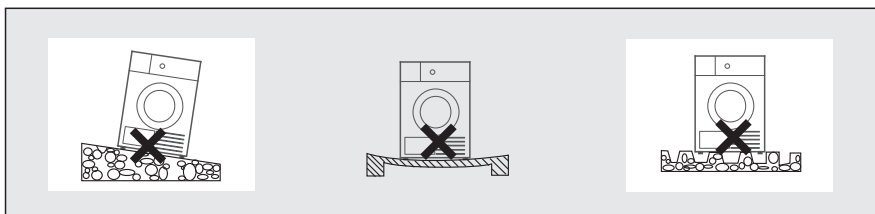

Level Adjusting

Once in its permanent operating position, check that the dryer is absolutely level with the aid of a spirit level. If it is not, adjust the feet by hand or using a tool.

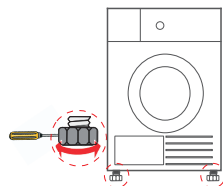

Power Supply Connection

1. Make sure that the voltage of the power supply is the same as the electric specification.
2. Do not connect the dryer with the power connection board, a universal plug or socket, do not use multi-plug adapters and extension cables.

Note!

- Leave it to stand for 2 hours after transporting. Before first use, please use the soft fabric to clean the inside drum.
 1. Put some clean rags into the drum.
 2. Plug the power, press **【On/Off】**.
 3. Select the **【Refresh】** Programme, press **【Start/Pause】** button.
 4. After finishing this programme, please follow the "Cleaning and Care" (refer to page 28) to clean the door filter.
- During drying, the compressor and the water will generate some noise which is entirely normal.

OPERATION

■ Quick Start

Note!

Before using, make sure the tumble dryer is installed correctly.

Before Drying

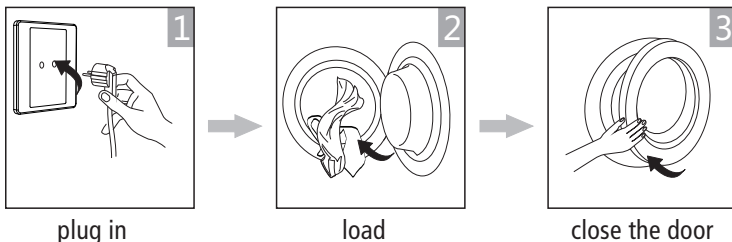

Drying



After Drying

Buzzer beep and "End" on display.

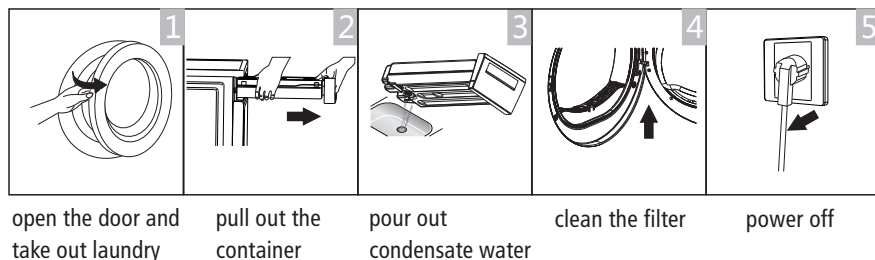

Note!

- If the socket with a switch is used, please press the switch to turn off the power directly.











OPERATION

■ Before Each Drying

1. Before drying, thoroughly spin the laundry in washing machine. High spin speed shortens the drying time and saves energy.
2. For uniform drying result, sort the laundry according to fabric type and select the appropriate drying programme.
3. Before drying, please close zips, hooks and eyelets, button, tie fabric belts, etc.
4. Remove all objects from pockets such as lighters and matches.
5. Sew in or remove underwiring from bras.
6. Close duvet covers and pillow cases to prevent small items from being rolled up inside them.
7. Leave jackets open and undo any long zips so that textiles dry evenly.
8. Do not over dry the clothes, because over dried clothes can easily get creases.
9. Do not dry the articles containing rubber or similar elastic materials.
10. Keep the area around the tumble dryer clean. Coal dust or flour may cause an explosion.
11. The door shall be opened only after the programme of the tumble dryer is finished to avoid being scalded by hot steam or over heated drying machine.
12. Clean the lint filter and empty water container after each use to avoid extension of drying time and increase of energy consumption.
13. Do not dry clothes after dry-clean process.

OPERATION

The reference weight of dry clothes (weight per item)

| | | | |
|---|---|--|---|
|  Sweater (mixed 800g) |  Jacket (cotton 800g) |  Jeans (800g) |  Bath Towel (cotton 900g) |
|  Single bedsheet (cotton 600g) |  Work clothes (1120g) |  Pyjamas (200g) |  Shirt (cotton 300g) |
|  T-Shirt (cotton 180g) |  Underwear (cotton 70g) |  Socks (mixed-weave 50g) | |

Note!

- Do not put more load than rated.
- Do not dry dripping wet laundry. The dryer might get damaged

Only dry laundry suitable for tumble drying. Regard the laundry care labels:



Suitable for tumble drying



Normal drying process: Drying in the tumbler is possible under normal load and temperature 80°C.



Mild drying process: Caution is appropriate when tumble drying. Select mild process with reduced thermal action.



Do not tumble dry: Articles unsuitable for drying in the tumbler.

OPERATION

■ Control Panel

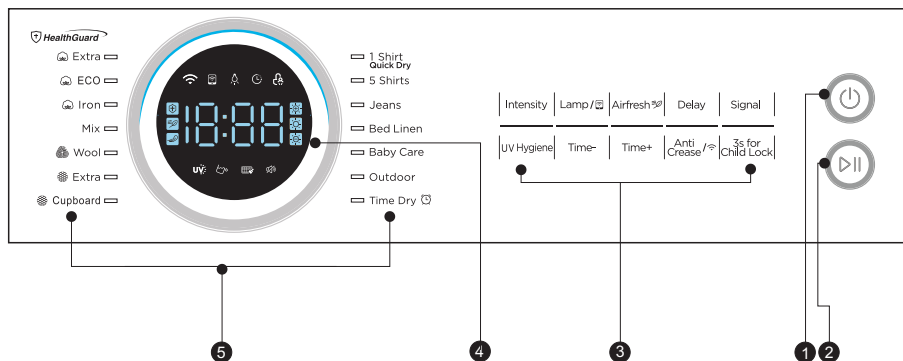

1 On/Off

Product is switched on or off.

2 Start/Pause

Press the button to start or pause the drying cycle.

3 Option

These buttons are used for setting additional functions.

4 Display

The display shows the setting, estimated program time remaining and status messages of your dryer.

5 Programmes

Different drying cycles can be selected according to the users need and the type of laundry to be dried.

OPERATION

■ Option

Delay



Delay

This function is used for delaying the start of the drying programme up to 24 hours. When the delayed programme starts, the time starts to countdown on the display and the delay icon illuminates.

1. Load your laundry and make sure the machine door is closed.
2. Press the **【⏸】** button, then use the programme selector knob to select the desired programme.
3. You can additionally select the **【Anti-Crease】** or **【Signal】** functions according to your need.
4. Press the **【Delay】** button.
5. Repeatedly press the **【Delay】** button to select the desired delay time.
6. After the **【▶||】** button is pressed, the Dryer is at the running condition. The drying procedure will be automatically performed when the delay time is over.
7. If you press the **【▶||】** button again, the delay function will be paused.
8. If you want to cancel the "Delay" function, please press the **【⏸】** button.

Time



Time

When the **【Time Dry】** or **【Airfresh】** or **【Warm】** programme is selected, the **【Time+】**, **【Time-】** button can be used to adjust the drying time in 10 min. steps.

Intensity



Intensity

You can adjust the dryness level of the laundry by pressing the **【Intensity】** button. There are three grades.

1. The intensity function can be adjusted only before the programme starts.
2. Press the **【Intensity】** button repeatedly to increase the drying grade.
3. Except the **【ECO】**, **【Cotton Extra】**, **【Time Dry】**, **【Wool】**, **【Cotton Iron】**, **【Airfresh】**, **【Warm】**, all the other programmes can be adjusted with the **【Intensity】** function.

Lamp



Lamp

The drum light will be on for 1 minute when the button is pressed or 1 minute when the door is open.

Signal



Signal

Set the buzzer on or off. In default condition, the buzzer is on.

When the buzzer is on:

1. The dryer will affirm pressed function button by a sound.
2. If the programme knob is rotated during the dryer is running, the buzzer will remind the user that this is an invalid operation.
3. When the drying programme is done, the buzzer will beep.

OPERATION



Anti-Crease

At the end of the drying cycle, the anti-crease time is 30 minutes (default) or 120 minutes (selected). This function prevents the laundry from creases. The laundry can be removed during the anti-crease phase. Except **【Wool】** , **【Time Dry】** and **【Airfresh】** , all the other programmes have this function.



Child Lock

1. This machine incorporates a special child safety lock, which can prevent children from carelessly pressing buttons or making the faulty operation.
 2. When the dryer is running or pausing, press the **【^{3s for} Child Lock**】 at the same time for 3 seconds to activate child lock.
 3. When child lock function is set, the display will show Child lock icon and all button are deactivated, except **【Lamp】** , **【Signal】** and **【】** button.
 4. To deactivate the child lock function, the **【^{3s for} Child Lock**】 button shall be pressed at the same time for 3 seconds.
-



Wireless Network

To activate wireless network function and connect your appliance to the internet, press **【】** 3 seconds. For details on first installation of wireless network connection refer to App setup section of this manual (page26).



Remote Control

After connecting your device to wireless network press **【】** 3 seconds to activate remote control state and control your appliance via smartphone.

Smartphone remote control should meet following condition:

1. Wireless network is activated and the appliance is connected to the internet.
2. The door of the appliance is closed.

Note:

- If the door is opened during remote control state, the function is switched off.
 - The remote control function is turned off at the end of each cycle automatically, if you want to use remote control function again, you need turn on it again.
-

OPERATION



UV Hygiene

After selecting the program, you can choose the **【UV Hygiene】** function according to your needs. Press **【UV Hygiene】** to select this function.

Press it again to cancel. After selecting the **【UV Hygiene】** function, germs are removed during the drying process, making the clothes cleaner and safer.

Use this function with caution for light, thin or delicate laundry.

【Bed Linen】, **【Out door】**, **【Baby Care】**, **【Mix】**, **【Synthetic】** and **【UV Hygiene】** programs have UV Hygiene function activated.

You can deactivate the UV Hygiene function for these programmes, by pressing the **【Lamp】** button for 3 seconds.



















Airfresh

For single or multi-layer cotton laundry to be dried completely for direct storage.

OPERATION

■ Display

| | |
|---|--|
|  | Delay |
|  | Child Lock |
|  | Remaining Time indicator/Error message |
|  Filter | Clean filters warning |
|  | Empty water container warning |
|  | Intensity (Iron, cupboard, extra) |
|  | Lamp |
|  | Signal |
|  | Anti-Crease |
|  | UV |
|  | Wireless Network |
|  | Remote Control |
|  | Hygiene |
|  | Airfresh |
|  | Cotton suitable for cotton and linen loads |
|  | Wool suitable for wool loads |
|  | Cupboard suitable for cupboard loads |



The wool drying cycle of this machine has been tested and approved by The Woolmark Company. The cycle is suitable to dry wool garments which are labelled “hand wash” provided that the garments are washed in a Woolmark endorsed hand washing cycle and dried according to the instructions issued by the manufacturer. M2206.

OPERATION

■ Programmes

Before starting the appliance

1. Inset the plug into the socket.
2. Put your laundry loosely inside the drum.
3. Close the door. Take care not to trap any items.
4. Switch on the machine.

Programme selector

1. When the LED display screen brightens up, rotate the programme knob to select the desired programme.
2. Select the **【Time】** , **【Anti - Crease】** , **【Delay】** , **【Hygiene】** or **【Intensity】** functions for additional options.
3. Press the **【Start/Pause】** button.
4. Press the **【On/Off】** button after the programme has completed.

Programme start





The drum will rotate after the programme starts. The cycle phase LED in the display will light up and the remaining programme time will be displayed.

Programme end

1. The drum will stop rotating after the programme ends. The display will show "End" and related LED will illuminate. The dryer will start **【Anti-Crease】** function if user doesn't remove the load. (Refer to page 19).
After the load is removed, press **【On/Off】** to switch off if the display is on. Drying is complete, please unplug.
2. Deal with the problems according to "Trouble Shooting" section, if there is an unexpected stop during the drying procedure or the dryer shows an Error Code (Refer to page 31).

OPERATION

■ Drying Programmes Table(*Programmes can be set in App)



| Programme | | Max Load | Application/Properties | Delay | Time |
|---|-----------|---|---|-------|------|
|  | Extra | 10.0kg | For single or multi-layer cotton laundry to be dried completely, for direct storage. | Y | N |
| | ECO | | | | |
| | Iron | | For single layer cotton laundry to remain damp for ironing. | | |
| | Mix | 4.0kg | For mixed fabrics from cotton and synthetics. | Y | N |
|  | Extra | 4.0kg | For thick or multi-layer synthetic fabrics to be dried completely. | Y | N |
| | Cupboard | | To dry thin synthetic textiles, which are not ironed, such as easy care shirts, baby cloths or socks. | | |
|  | Wool | 1.0kg | Suitable for auxiliary drying of machine washable wool clothing. | Y | N |
|  | 1 Shirt | 0.2kg | Place clothes loosely in the dryer. Once dried, remove quickly and hang it on a clothes hanger. Easy care laundry (small amount of thin synthetics), such as shirts and blouses equipped with anti-crease functionality to minimize the ironing effort. | Y | N |
| | 5 Shirts | 1.0kg | | Y | N |
| | Jeans | 5.0kg | To dry jeans or leisure clothes that are spun at high speed in the washing machine. | Y | N |
| | Bed Linen | 5.0kg | To dry bed linen, bed sheets or other large items | Y | N |
| | Baby care | 1.0kg | To dry small amount of baby clothing | Y | N |
| | Outdoor | 3.0kg | To dry outdoor clothing, waterproof and breathable laundry items which are suitable for drying in tumble dryer | Y | N |
| | Time Dry | — | To dry individual items or complete the drying process of multi-layer fabrics with different drying behavior, such as jackets, pillows or voluminous items. Min 10 min. to max. 180min. (in 10 min. steps) | Y | Y |
| Airfresh | 1.0kg | To refresh your laundry using cold air, select any program and press the 【Air fresh】 button, the program time change to 20min and () is indicated in the display, press 【Air fresh】 again to deactivate and change back to the selected program. | Y | Y | |

• Note for Test Institutes:

1.  ECO is the test programme in accordance with Regulation 392/2012/EU for energy labelling, measured in accordance with EN 61121 and suitable for drying normal cotton load at rated load capacity.
2. This programme is suitable for drying normal wet cotton laundry and it is the most efficient programme in terms of energy consumption for cotton.

OPERATION

■ Consumption Data ①

| Model | Program | Capacity | Spin Speed / Residual Humidity | Drying Time | Energy Consumption |
|---------------------------|--|----------|--------------------------------|-------------|--------------------|
| MD200H100W MD200H100WT |  ECO | 10kg | 1000rpm / 60% | 230min | 1.75kWh |
| | | 5kg | 1000rpm / 60% | 150min | 0.95kWh |
| |  Cupboard | 4kg | 800rpm / 40% | 80min | 0.60kWh |

Note!

- Thick or multi-layered fabrics, e.g. jackets etc., are not easy to dry. It is recommended to choose Cotton Extra programme or use "Intensity" function.
- As uneven material, thick and multi-layered clothes are not easy to dry, it is better to choose the appropriate time drying programme to completely dry them if some parts of the clothes are still damp after programme finishes.

① All data are measured in accordance with EN 61121.

The actual consumption may differ from the values given in the table, depending on the amount of the laundry, type of fabric, residual moisture and any additional functions selected.

OPERATION

■ App Setup And Operation

Use Your Appliance With the SmartHome App

Before you start, make sure that:

1. Your smartphone is connected to home wireless network, and you know the network password.
2. You are near the home appliance.
3. The 2.4GHz band wireless signal is enabled on your wireless router.

Follow the below steps to enter the remote control state

Download the SmartHome App

On an app market (Google Play Store, Apple App Store), search for "SmartHome*" and find the SmartHome app. Download and install it on your phone. You can also download the app by scanning the QR code.



Register and Log In

Open the SmartHome app, and create a new account to start (you can also register through a third-party account). If you already have an existing account, use the account to log in.



Connect Your Devices to SmartHome

1. Please make sure your mobile phone is connected to the home wireless network. If it is not, go to settings and enable wireless networks and bluetooth.
2. Please power on your device.
3. Open SmartHome app on your phone.
4. If a message of "Smart devices discovered nearby" appears, click to add.
5. If no message appears, select "+" on the page and select your device in the list of nearby devices available. If your device is not listed, please add your device manually by the device category and device model.
6. Connect your device to the wireless network according to instructions on app. If the connection fails, please follow the instructions provided by the app to continue with the operation.



OPERATION

Start the Remote Control

Rotate the knob randomly to indicate one of the programs, and press [Lamp /] continuously until the remote control icon light up in the knob display, which means it has entered the remote control state and you can start to control remotely.

Wireless Network Status Light

| | |
|------------------|-----------------------------------|
| Slowly flashing | Waiting for connection |
| Quickly flashing | Connecting |
| Ever bright | Connected to your wireless router |

NOTE

1. Make sure your devices are powered on.
2. Keep your mobile phone close enough to your device when you are connecting your device to the network.
3. Connect your mobile phone to the wireless network at home, and make sure you know the password of the wireless network.
4. Check if your wireless router supports 2.4 GHz band and turn it on. If you are not sure whether the router supports 2.4 GHz band, please contact the router manufacturer.
5. The device cannot connect to the wireless network that requires authentication, and it usually appears in public areas such as hotels, restaurants, etc. Please connect to a wireless network that does not require authentication.
6. Turn off the WLAN+ (Android) or WLAN Assistant (iOS) function of your mobile phone when connecting your device to the network.
7. In the case that your device connected to a wireless network before but it needs to reconnect, please click "+" on the app Home page, and add your device again by the device category and model according to the instructions on app.
8. The Max RF Output Power: Bluetooth LE: 8dBm, 2.4GHz Wireless Network: 18dBm. Frequency band of operation: 2400-2483.5MHz.

MAINTENANCE

■ Cleaning and Care

Empty the water container

1. Pull out and hold the water container with two hands.
2. Tilt the water container, pour out the condensate water into the basin.
3. Install the water container.

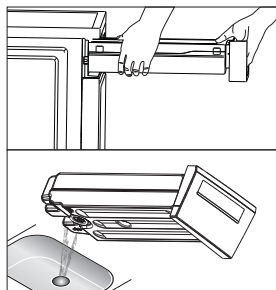

⚠ WARNING!

- Empty the water container after each use. Once the water container is filled completely, the programme will be paused and the "🔌" icon will light. After the container is emptied, the dryer can be restarted by pressing **【Start/Pause】** button.
- Do not drink the condensate water.
- Do not use the dryer without the water containers.

Clean the filters

This dryer has a primary door lint filter.

Make sure you clean the door filter after each cycle.

📌 Note!

- To ensure the double-layer filter can be closed smoothly, the arrows at both ends need to be aligned, and the middle slot and the rib need to be aligned.

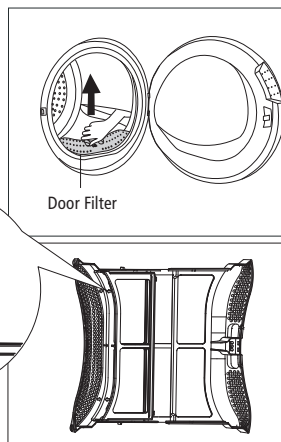

Clean the door filter

1. Open the door.
2. Take out the door filter.
3. Open the filter and remove the fluff on the filter screen.
4. Dry the door filter thoroughly before installing it back.

📌 Note!

- Take notice of the correct orientation before to insert the door filter.

MAINTENANCE

Clean the heat exchanger

⚠ WARNING!

Do not touch the heat exchanger with your hand, which may cause an injury.

- As necessary, approx. once every 3 months, remove the fluff from the heat exchanger using a vacuum cleaner with a dusting brush attached.
- Clean the heat exchanger without applying any pressure. Otherwise the heat exchanger could be damaged. The dryer will not dry if the cooling fins are damaged or bent.

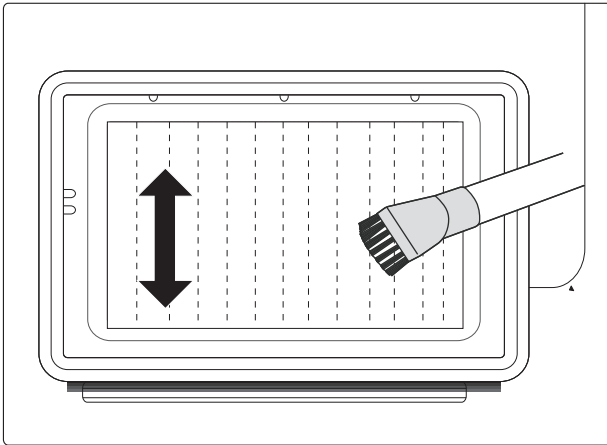

MAINTENANCE

Clean Tumble dryer

⚠ WARNING!

- Disconnect the power cord before cleaning!
- Clean the dryer with a wet cloth which is only damped by clean water.
- Do not use solvents, abrasive cleaners, glass cleaners or all-purpose cleaners. These could damage plastic surfaces and other parts.
- Please wear gloves when cleaning.

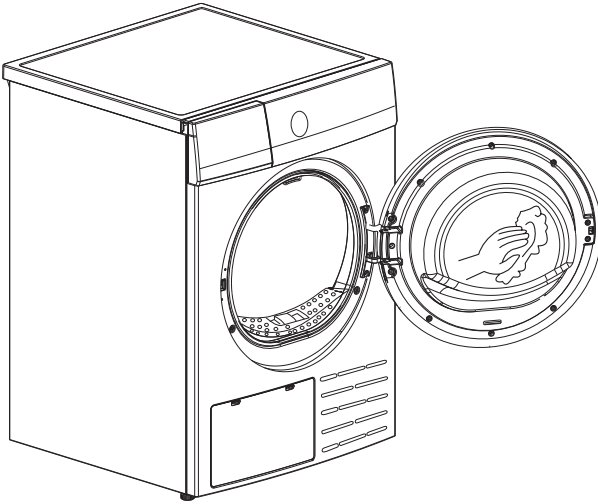

- Prepare a wet cloth damped by clean water.
- Clean the door, especially the inside window.
- Clean the sealing around the door opening.
- Clean the humidity sensor inside the drum.
- Take out the filter, clean the sealing and air flow openings.
- Before starting the dryer, dry all parts with a soft cloth.

MAINTENANCE

■ Trouble Shooting

Many malfunctions and faults that might occur in daily operation can be easily remedied. Time and money will be saved because a service call won't be needed. The following guide may help you to find the reason for a malfunction and correct it.

| Display | Reason | Solutions |
|---|--|---|
|  | Container is full | Empty water container |
| | Water pump failure or water level sensor failure | |
| "E33" | Temperature sensor error | Pull out the plug from the socket. Please contact your local service center if the problem occurs. |
| "E64" | BLDC motor communication error | |
| "E82" | PCB communication error | |



WARNING!

- Only authorised technicians can carry out repairs.
- If the LED displays other prompt and the dryer does not work, pull out the plug from the socket, please call the service.

Note!

Before you call the service, please check if you have dealt with the problems yourself consulting the user instructions.

MAINTENANCE

| Problem | Solution |
|---|---|
| <ul style="list-style-type: none"> • Display is not on | <ul style="list-style-type: none"> • Check if the mains plug is inserted. • Check if the power supply works. • Check the selected programme . • Press the 【On/Off】 button. |
| <ul style="list-style-type: none"> • “” is lighting | <ul style="list-style-type: none"> • Check the water container. If it's full, please pour out the condensate water and restart the dryer. • If the container is not full, please restart the dryer directly. • If the “” icon is still lighting after you have finished the first two steps, please call the service. |
| <ul style="list-style-type: none"> • “” is lighting | <ul style="list-style-type: none"> • Clean the lint filter. |
| <ul style="list-style-type: none"> • Dryer does not start | <ul style="list-style-type: none"> • Connect the tumble dryer to the mains. • Turn on the tumble dryer. • Check the the door is closed. • Check the programme is set. • Press the 【Start/Pause】 button. |
| <ul style="list-style-type: none"> • Degree of dryness was not reached or drying time too long | <ul style="list-style-type: none"> • Clean lint filter and heat exchanger. • Empty the water container. • Check the drain hose. • Check installation place is appropriate. • Keep the air inlet clean. • Use higher drying intensity level programme or time programme. |
| <ul style="list-style-type: none"> • There are humming noises | <ul style="list-style-type: none"> • The compressor is operating. These noises are normal and do not indicate a fault. |
| <ul style="list-style-type: none"> • The dryer switches off at the end of the programme | <ul style="list-style-type: none"> • The dryer switches off automatically for energy saving. This is not an error but a normal function. |

WARNING!

If you cannot deal with the problems by yourself and need help:

- Press the **【On/Off】** button.
- Pull out the mains plug and call the service.

MAINTENANCE

■ Technical Specifications

| Parameter \ Model | MD200H100W MD200H100WT |
|-------------------------|---------------------------|
| Dimension(L*W*H) | 595*675*845(mm) |
| Ambient temperature | +2°C ~ +35°C |
| Rated input power | 750W |
| Rated voltage | 220-240V~ |
| Rated frequency | 50Hz |
| Refrigerant | R290 |
| Weight of product | 48kg |
| Rated capacity | 10.0kg |
| GWP | 3 |
| CO ₂ - eq | 0.00t |
| Quantity of refrigerant | 130g |

Note!

- The rated capacity is the maximum capacity to be dried at one time. Make sure that the dry clothes which are loaded into the appliance do not exceed the rated capacity.
- Do not install the tumble dryer in a room when there is a risk of frost occurring. At temperatures around freezing point the tumble dryer may not be able to operate properly.
- There is a risk of damage if the condensate water is allowed to freeze in the pump, hoses and / or condensate water container.



make yourself at home