

## PORTABLE AIR CONDITIONER



SmartHome

Download the app  
& activate product



## USER MANUAL

**MAP08S1XWT**  
**MAP10S1XWT**  
**MAP10HS1XWT**



Before using this product, please read this manual carefully and keep it for future reference. The design and specifications are subject to change without prior notice for product improvement. Consult with your dealer or the manufacturer for details.

## THANK YOU LETTER

Thank you for choosing Midea! Before using your new Midea product, please read this manual thoroughly to ensure that you know how to operate the features and functions that your new appliance offers in a safe way.

# CONTENTS

<b>THANK YOU LETTER</b> .....	2
<b>SAFETY PRECAUTIONS</b> .....	3
<b>BEFORE YOU GET STARTED</b> .....	8
<b>INSTALLATION INSTRUCTIONS</b> .....	10
<b>OPERATING INSTRUCTIONS</b> .....	18
<b>CLEANING &amp; MAINTENANCE</b> .....	21
<b>TROUBLESHOOTING TIPS</b> .....	23
<b>REMOTE CONTROL AND APP INSTRUCTIONS</b> .....	24
<b>WARRANTY</b> .....	41

## Read This Manual

Inside you'll find many helpful hints on how to use and maintain your air conditioner properly. Just a little preventative care on your part can save you a great deal of time and money over the life of your air conditioner. You'll find many answers to common problems in the troubleshooting tips - you should be able to fix most of them quickly before calling service. These instructions may not cover every possible condition of use, so common sense and attention to safety is required when installing, operating and maintaining this product.



### CAUTION

- For support, please call the Service Center at 1-866-646-4332.
- This appliance is not intended for use by people (including children) with reduced physical, sensory or mental capabilities or lack of experience and knowledge, unless they have been given supervision or instruction concerning use of the appliance by a person responsible for their safety.
- Children should be supervised to ensure that they do not play with the air conditioner.
- The appliance shall be installed in accordance with national wiring regulations.
- Do not operate your air conditioner in a humid room such as a bathroom or laundry room.

# SAFETY PRECAUTIONS

## Must Read the Warning Message

Read Safety Precautions Before Operation and Installation.

To prevent property damage, injury or death to user or other people, the instructions in this manual must be followed. Incorrect operation due to ignoring of instructions may cause damage, harm, or death.

The level of risk is shown by the following indications.



### WARNING

This symbol indicates a hazardous situation which, if not avoided, could result in death or serious injury.



### CAUTION

This symbol indicates a hazardous situation, which, if not avoided, could result in minor or moderate injury.

### NOTICE

This symbol addresses practices not related to physical injury.



### WARNING

- Installation must be performed according to the installation instructions. Improper installation can cause water leakage, electrical shock, or fire.
- Use only the included accessories and parts, and specified tools for the installation. Using nonstandard parts can cause water leakage, electrical shock, fire, and injury or property damage.
- Make sure that the outlet you are using is grounded and has the appropriate voltage. The power cord is equipped with a three-prong grounding plug to protect against shock. Voltage information can be found on the nameplate of the unit.
- Your unit must be used in a properly grounded wall receptacle. If the wall receptacle you intend to use is not adequately grounded or protected by a time delay fuse or circuit breaker, have a qualified electrician install the proper receptacle (the fuse or circuit breaker needed is determined by the maximum current of the unit. The maximum current is indicated on the nameplate located on unit).
- Do not touch the unit with wet or damp hands or when barefoot.
- If the air conditioner is knocked over during use, turn off the unit and unplug it from the main power supply immediately. Visually inspect the unit to ensure there is no damage. If you suspect the unit has been damaged, contact a technician or customer service for assistance.
- In a thunderstorm, the power must be cut off to avoid damage to the machine due to lightning.
- Your air conditioner should be used in such a way that it is protected from moisture. e.g. condensation, splashed water, etc. Do not place or store your air conditioner where it can fall or be pulled into water or any other liquid. Unplug immediately if it occurs.
- Install the unit on a flat, sturdy surface. Failure to do so could result in damage or excessive noise and vibration.

## **WARNING**

- The unit must be kept free from obstruction to ensure proper function and to mitigate safety hazards.
- Do not modify the length of the power cord or use an extension cord to power the unit.
- Do not share a single outlet with other electrical appliances. Improper power supply can cause fire or electrical shock.
- Do not install your air conditioner in a wet room such as a bathroom or laundry room. Too much exposure to water can cause electrical components to short circuit.
- Do not install the unit in a location that may be exposed to combustible gas, as this could cause fire.
- The unit has wheels to facilitate moving. Make sure not to use the wheels on thick carpet or to roll over objects, as this could cause the unit to tip over.
- Do not operate a unit that has been dropped or damaged.
- Ensure the unit remains at least 3ft (1m) away from any combustible materials such as bedding, curtains, and furniture.
- All wiring must be performed strictly in accordance with the wiring diagram located inside of the unit.
- The unit's circuit board (PCB) is designed with a fuse to provide overcurrent protection. The specifications of the fuse are printed on the circuit board, such as: T 3.15A/250V, etc.
- When the water drainage function is not in use, keep the upper and lower drain plug firmly attached. When the drain plug is not in use, keep it out of reach of children to avoid a choking hazard.

## **CAUTION**

- This appliance is not intended for use by persons (including children) with reduced physical, sensory or mental capabilities or lack of experience and knowledge, unless they have been given supervision or instruction concerning use of the appliance by a person responsible for their safety.
- Children should be supervised to ensure that they do not play with the appliance. Children must be supervised around the unit at all times.
- If the supply cord is damaged, it must be replaced by the manufacturer, its service agent or similarly qualified persons in order to avoid a hazard.
- Do not use this product for functions other than those described in this instruction manual.
- Before cleaning, turn off the power and unplug the unit.
- Disconnect the power if strange sounds, smell, or smoke comes from it.
- Do not press the buttons on the control panel with anything other than your fingers.
- Do not remove any fixed covers. Never use this appliance if it is not working properly, or if it has been dropped or damaged.



## CAUTION

- Do not operate or stop the unit by inserting or pulling out the power cord plug.
- Do not use hazardous chemicals to clean or come into contact with the unit. Do not use the unit in the presence of inflammable substances or vapour such as alcohol, insecticides, petrol, etc.
- Prior to cleaning or other maintenance, the appliance must be disconnected from the supply mains.
- Do not remove any fixed covers. Never use this appliance if it is not working properly, or if it has been dropped or damaged.
- Do not run cord under carpeting. Do not cover cord with throw rugs, runners, or similar coverings. Do not route cord under furniture or appliances. Arrange cord away from traffic area and where it will not be tripped over.
- Do not operate unit with a damaged cord, plug, power fuse or circuit breaker. Discard unit or return to an authorized service facility for examination and/or repair.
- To reduce the risk of fire or electric shock, do not use this fan with any solid-state speed control device.
- The appliance shall be installed in accordance with national wiring regulations.
- Contact the authorized service technician for repair or maintenance of this unit.
- Contact the authorized installer for installation of this unit.
- Do not cover or obstruct the inlet or outlet grilles.
- Always transport your air conditioner in a vertical position and stand on a stable, level surface during use.
- Always contact a qualified person to carry out repairs. If the damaged power supply cord must be replaced, use a new power supply cord obtained from the product manufacturer. Do not repair the damaged cord.
- Hold the plug by the head of the power plug when taking it out.
- Turn off the product when not in use.

## FOR R32 REFRIGERANT MODEL



**CAUTION:**  
Risk of fire  
**flammable materials**

**IMPORTANT NOTE:** Read this manual carefully before installing or operating your new appliance. Make sure to save this manual for future reference.

### Explanation of symbols displayed on the unit



**CAUTION**

This symbol shows that the operation manual should be read carefully.



**CAUTION**

This symbol shows that a service personnel should be handling this equipment with reference to the installation manual.



**CAUTION**

This symbol shows that information is available such as the operating manual or installation manual.

## **WARNING**

- Servicing shall only be performed as recommended by the equipment manufacturer. Maintenance and repair requiring the assistance of other skilled personnel shall be carried out under the supervision of a person competent in the use of flammable refrigerants.
- DO NOT modify the length of the power cord or use an extension cord to power the unit.
- DO NOT share a single outlet with other electrical appliances. Improper power supply can cause fire or electrical shock.
- Please follow the instruction carefully to handle, install, clean, and service the appliance to avoid any damage or hazard.

### **Flammable**

#### **Refrigerant R32 is used within appliance.**

- When maintaining or disposing of the appliance, the refrigerant (R32) shall be recovered properly and shall not discharge to air directly.
- Compliance with national gas regulations shall be observed.
- Keep ventilation openings clear of obstruction.
- The appliance shall be stored so as to prevent mechanical damage from occurring.
- A warning that the appliance shall be stored in a well-ventilated area where the room size corresponds to the room area as specified for operation.

## **WARNING**

- Any person who is involved with working on or breaking into a refrigerant circuit should hold a current valid certificate from an industry-accredited assessment authority, which authorizes their competence to handle refrigerants safely in accordance with an industry recognized assessment specification.

Examples for such working procedures are:

- Breaking into the refrigerating circuit;
  - Opening of sealed components;
  - Opening of ventilated enclosures.
- 
- No open fire or device like switch which may generate spark/arcing shall be around the appliance to avoid causing ignition of the flammable refrigerant used. Please follow the instruction carefully to store or maintain the appliance to prevent mechanical damage from occurring.
  - Do not use means to accelerate the defrosting process or to clean, other than those recommended by the manufacturer.
  - The appliance shall be stored in a room without continuously operating ignition sources (for example: open flames, an operating gas appliance) and ignition sources or (for example: an operating electric heater) close to the appliance.
  - Do not pierce or burn.
  - Be aware that the refrigerants may not contain an odor.

# BEFORE YOU GET STARTED

## Preparations Before Installation



The installation must be carried out in strict accordance with the instructions in this manual.



We recommend doing this with a helper.



Installing your AC should take about 30 minutes.



We're here if you need us, please contact 1-866-646-4332

## Ambient Temperature Range For Unit Operating:

MODE	Temperature Range	MODE	Temperature Range
Cool	16-35°C (60-95°F)	Heat(pump heat mode)	5-30°C (41-86°F)
Dry	13-35°C (55-95°F)	Heat(electrical heat mode)	≤ 30°C (86°F)

## Know your Portable Air Conditioner

### Energy Rating Information

The energy rating and noise information for this unit is based on the standard installation using an un-extended exhaust duct without window slider adaptor (as shown in the Installation section of this manual). At the same time, the unit must be operate on the COOL MODE and HIGH FAN SPEED by remote controller.

The unit with 3 meters extended exhaust duct is running by using 2 exhaust ducts (Diameter:150mm, Length: 1.5m + Diameter: 130mm, Length: 1.5m).The Energy rating and noise information for unit with 3 meters extended exhaust duct is not assessed. (For some models)

### NOTE:

We recommend that operating the unit at room temperature below 35°C. Since there is a risk that the unit with 3 meters extended exhaust duct would not work at room temperature above 35°C under some extreme conditions, such as the lower air intake be blocked for 50%.

### How to Stay Cool with a New Portable Air Conditioner (For the models comply with the requirements of Department Of Energy in US)

Because of a new federal test procedure for Portable Air Conditioners, you may notice that the cooling capacity claims on portable air conditioner packaging are significantly lower than that of models produced prior to 2017. This is due to changes in the test procedure, not to the portable air conditioners themselves.



### What Should I Look For First When Purchasing A Portable Air Conditioner?

The right air conditioner helps you cool a room efficiently. An undersized unit won't cool adequately while one that's too large will not remove enough humidity, leaving the air feeling damp. To find the proper air conditioner, determine the square footage of the room you want to cool by multiplying the room length by its width. You also need to know the air conditioner's BTU (British Thermal Unit) rating, which indicates the amount of heat it can remove from a room. A higher number means more cooling power for a larger room. (Be sure you are comparing only newer models to each other. Older models may appear to have a higher capacity, but are actually the same). Be sure to "size up" if your portable air conditioner will be placed in a very sunny room, in a kitchen, or in a room with high ceilings. After you've found the right cooling capacity for your room, you can look at other features.

### Why Newer Products Have Lower Cooling Capacity Than Older Models

Federal regulations require manufacturers to calculate cooling capacity based on a specific test procedure, which was changed just this year. Models manufactured before 2017 were tested under a different procedure and cooling capacity was measured differently in prior year's models. So, while the BTUs may be lower now, the actual cooling capacity of the air conditioners has not changed.

### What is SACC?

SACC is the representative value of Seasonally Adjusted Cooling Capacity, in Btu/h, as determined in accordance with the DOE test procedure at title 10 Code of Federal Regulations (CFR) 430, subpart B, appendix CC and applicable sampling plans.

## Electronic Work



**WARNING:**  
BEFORE PERFORMING ANY ELECTRICAL OR WIRING WORK, TURN OFF THE MAIN POWER TO THE SYSTEM.

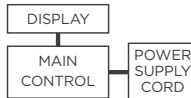

**NOTE:** The cognographs are for explanation purpose only. Your machine may be slightly different. The actual shape shall prevail.

# INSTALLATION INSTRUCTIONS

## Product Installation Location

### Your Installation Location Should Meet The Following Requirements:

- Make sure that you install your unit on an even surface to minimize noise and vibration.
- The unit must be installed near a grounded plug, and the Collection Tray Drain (found on the back of the unit) must be accessible.
- The unit should be located at least 30cm (12") from the nearest wall to ensure proper air conditioning. The air outlet of the unit should be at least 50cm (19.7") away from obstacles.
- DO NOT cover the Intakes, Outlets or Remote Signal Receptor of the unit, as this could cause damage to the unit.

### Unit Installation Location Restricted Space Requirements

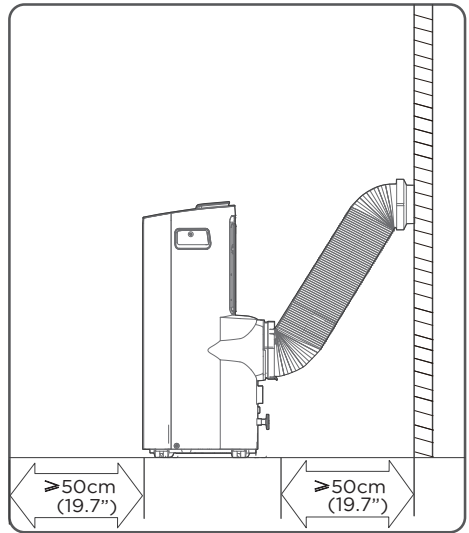
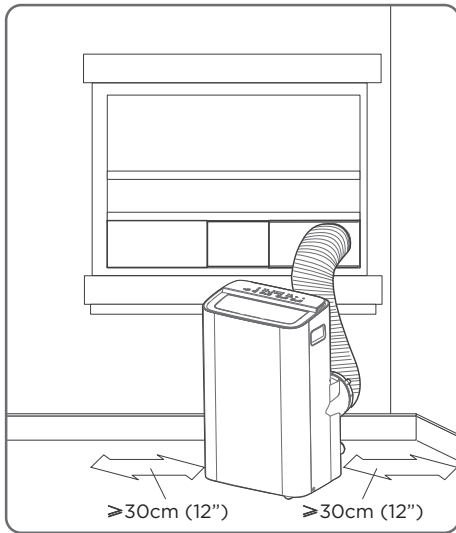

## Product Overview

### NOTICE

All the illustrations in the manual are for explanation purpose only. Your machine may be slightly different. The actual shape shall remain the same.

The unit can be controlled by the unit control panel alone or with the remote control.

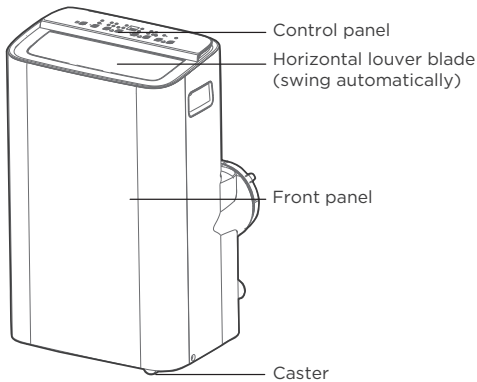

Front View

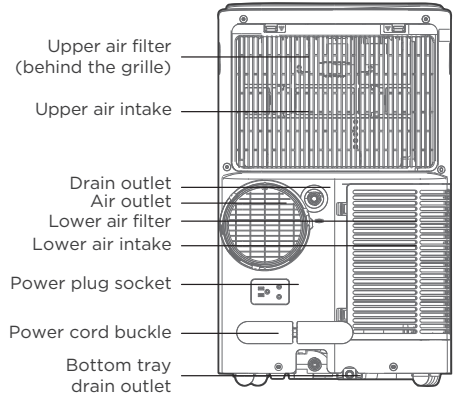

Rear View

### DESIGN NOTICE

In order to ensure the optimal performance of our products, the design specifications of the unit and remote control are subject to change without prior notice.

## Installation Overview

### Installation Completion Display

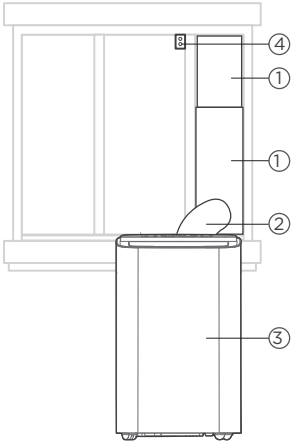

Sliding Window Installation

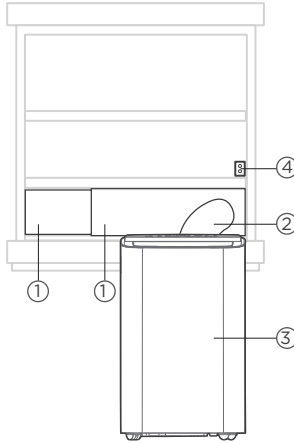

Hung Window Installation

1. Window Slider
2. Extended Exhaust Hose
3. Portable Air Conditioner
4. Security Bracket and 2 Screws

### NOTICE

Illustrations in this manual are for explanatory purposes. The actual shape of your indoor unit may be slightly different. The actual shape shall prevail.

## Tools Needed



Screwdriver & wrench



Pencil



A tape measure



Scissors or Knife



Saw (On some models, to shorten window adaptor for narrow windows)

## Installation Accessories

Your Window Installation Kit fits windows 19.4"-62.2"(49.3-158.1cm) and can be shortened for smaller windows.

### NOTICE

Items with (\*) are on some models. Slight variations in design may occur.

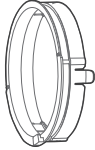

Unit Adaptor  
(1pc)

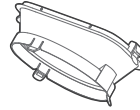

Air exhaust  
passage (1 pc\*)



Foam Seal A  
(Adhesive) 4 pc(\*)



Foam Seal B  
(Adhesive) 2 pc



Foam Seal C  
(Non-adhesive) 2 pc(\*)



Security Bracket  
and 2 Screws (1 set)



Drain Hose  
(1 pc)



Exhaust Hose  
(1 pc)



Bolt (3 pc)



Power Cord  
Buckle (1 pc)

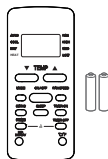

Remote Controller  
and Battery  
(1 set\*)



Window Sliders  
1 set(\*)

## Confirm Your Window Type (Window Type And Opening Size Of Different Types)

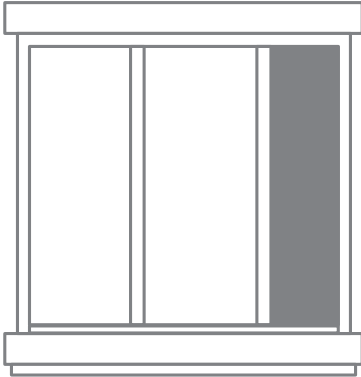

**Sliding Window Installation**

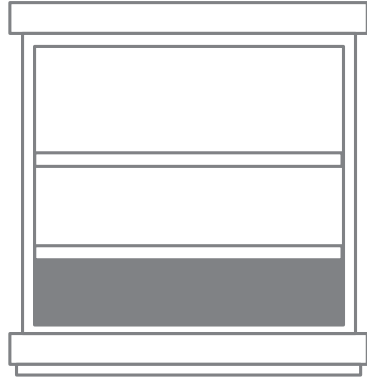

**Hung Window Installation**

## For Optimal Performance In Operation

### NOTICE

To ensure proper function, DO NOT overextend or bend the hose. Make sure that there is no obstacle around the air outlet of the exhaust hose (in the range of 500mm) in order to ensure the exhaust system works properly. All the illustrations in this manual are for explanation purpose only. Your air conditioner may be slightly different. The actual shape shall prevail.

### INCORRECT

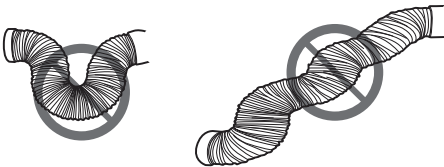

### CORRECT

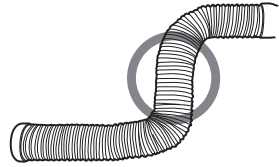

## Exhaust Hose And Adaptors Installation

### 1 - The Exhaust Hose Assembly Installation (Window Type):

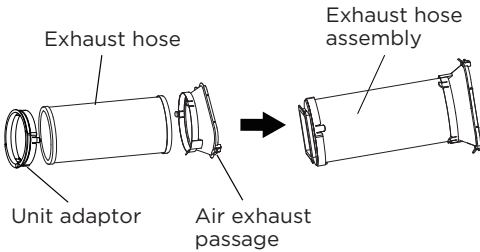

Press the exhaust hose (or extended exhaust hose) into the window slider adaptor and unit adaptor. The pieces will clip together using the tabs on the adaptors.

### NOTICE

Please install the exhaust hose assembly according to the fittings in your kit.

### 2 - Preparing the Adjustable Window Slider:

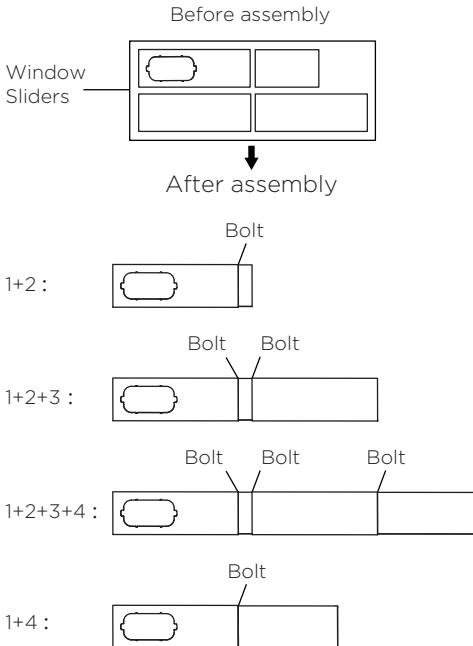

Choose the window sliders according to the size of your window. Some of the sliders may need to be cut to fit the exact window size, make sure to cut the sliders carefully if this is required.

Use bolts to fasten the window sliders once they are adjusted to the proper length.

### NOTICE

Please base your window slider installation on the accessories in your kit and the size of your window.

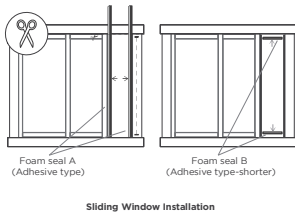
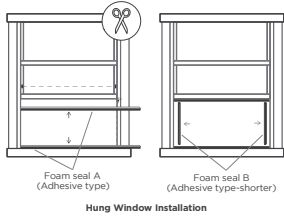

**NOTE:** Once the exhaust hose assembly and adjustable window slider are prepared, choose one of the two installation methods based on your window type.

### 3. Complete sealing of window

Cut the adhesive foam seal A and B strips to the proper lengths, and attach them to the window sash and frame as shown.

### 4. Hung Window Installation

#### Step 1:

Insert the window slider assembly into the window opening.

#### Step 2:

Cut the non-adhesive foam seal C strip to match the width of the window. Insert the seal between the glass and the window frame to prevent air and insects from getting into the room.

#### Step 3:

If desired, install the security bracket with 2 screws as shown.

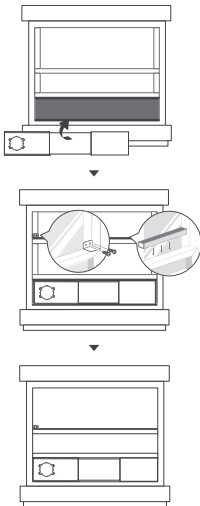



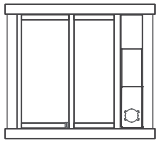
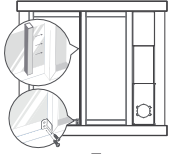
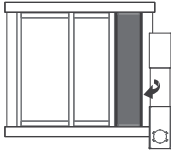

## 5. Sliding Window Installation

### Step 1:

Insert the window slider assembly into the window opening.

### Step 2:

Cut the non-adhesive foam seal C strip to match the height of the window. Insert the seal between the glass and the window frame to prevent air and insects from getting into the room.

### Step 3:

If desired, install the security bracket with 2 screws as shown.

Hook      Hook Seat



Adapter      Lower groove

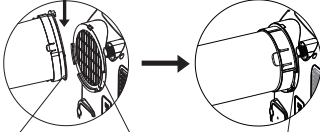

Make sure the adaptor is inserted into the lower groove of the air outlet.

## 6. Install The Exhaust Hose Assembly To The Unit:

Push the exhaust hose into the air outlet opening of the unit along the arrow direction.



Hung Window Installation

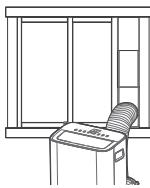

Sliding Window Installation

## 7. Connect The Adaptor To The Unit And The Window:

Insert the window slider adapter into the hole of the window slider.

# OPERATING INSTRUCTIONS

## Electronic Control Operating Instructions

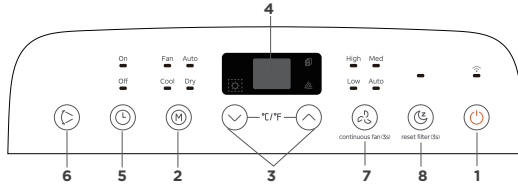

### 1. POWER Button

Power switch on/off .

Used to initiate the Wireless function. For the first time using the Wireless function, press and hold the POWER button for 3 seconds to initiate the Wireless connection mode. The LED DISPLAY shows 'AP' to indicate you can set Wireless connection. If connection (router) is successful within 8 minutes, the unit will exit Wireless connection mode automatically and the Wireless indicator light illuminates.

If connection fails within 8 minutes, the unit exits Wireless connection mode automatically. After Wireless connection is successful, you can press and hold POWER and DOWN (∨/-) buttons at the same time for 3 seconds to turn off wireless function and the LED display shows 'OF' for 3 seconds, press POWER and UP (∧/+) buttons at the same time to turn on Wireless function and the LED DISPLAY shows 'On' for 3 seconds.

### NOTICE

When you restart the Wireless function, it may take a period of time to connect to the network automatically.

### 2. MODE Function

See page 19 for more information on each mode. Selects the appropriate operating mode. Each time you press the button, a mode is selected in a sequence that goes from AUTO, COOL, DRY and FAN. The mode indicator light illuminates under the different mode settings.

### 3. UP (∧/+) and DOWN (∨/-) Buttons

Used to adjust (increasing/decreasing) temperature settings in 1°C/2°F (or 1°F) increments in a range of 16°C-30°C/60°F-86°F(or 88°F).

TIMER setting in a range of 0-24hrs.

### NOTICE

The control is capable of displaying temperature in degrees Fahrenheit or degrees Celsius. To convert from one to the other, press and hold the Up and Down buttons at the same time for 3 seconds.

### 4. DISPLAY

Shows the set temperature in °C or °F and the Auto-timer settings. While on DRY and FAN modes, it shows the room temperature.

Shows Error codes and protection code:

EH60-Room temperature sensor error.

EH61-Evaporator temperature sensor error.

EC52-Condenser temperature sensor error (on some models).

EH0b-Display panel communication error.

ELOC-Refrigerant leakage detection malfunction (on some models).

P1 - Bottom tray is full - Connect the drain hose and drain the collected water away. If protection repeats, call for service.

### NOTICE

When one of the above malfunctions occurs, turn off the unit, and check for any obstructions on any of the air inlet or outlet vents. Restart the unit, if the malfunction is still present, turn off the unit and unplug the power cord.

Contact the manufacturer, its service agents or a similar qualified person for service.

### 5. TIMER Button

Used to initiate the AUTO ON start time and AUTO OFF stop time program in conjunction with the UP & DOWN buttons. The timer on/off indicator light illuminates under the timer on/off settings.

## 6. SWING Mode

Used to initiate the Auto swing feature. When the operation is ON, press the SWING button to stop the louver at the desired angle.

## 7. CONTINUOUS FAN Function

In Cool or Dry mode, press and hold the Continuous Fan button for 3 seconds to turn the continuous fan function on or off. When the function is turned on, the continuous fan light will illuminate. When the function is turned off, the continuous fan light will turn off.

To control the fan speed, press the Continuous Fan button in four steps - LOW, MED, HIGH and AUTO.

The fan speed indicator light will illuminate under different fan settings.

## 8. SLEEP Mode

Press the sleep button to initiate sleep mode. While in this mode, the selected temperature will increase or decrease by 2°F (or 1°C) after 30 minutes.

The temperature will then increase or decrease by another 2°F (or 1°C) after an additional 30 minutes.

This new temperature will be maintained for 7 hours before it returns to the originally selected temperature. After the 7 hour period, sleep mode is automatically turned off and the unit will continue to operate as originally programmed.

### NOTICE

This feature is unavailable under FAN or DRY mode.

## 9. DRY Mode

To turn on Dry mode, press the "MODE" button until the "Dry" indicator light comes on. In this mode, the fan speed or the temperature cannot be adjusted. The fan motor operates at LOW speed.

### NOTICE

Keep windows and doors closed for the best dehumidifying effect.

## 10. AUTO Mode

When you set the air conditioner to AUTO mode, it will automatically select cooling, or fan only operation depending on what temperature you have selected and the room temperature. To turn on Auto mode, press the "MODE" button until the "Auto" indicator light comes on.

The air conditioner will control room temperature automatically around the temperature point set by you. Under AUTO mode, you can not select the fan speed.

### NOTICE

Under AUTO mode, both the AUTO mode and the actual operation mode indicator lights illuminate for some models.

## 11. COOL Mode

To turn on Cool mode, press the "MODE" button until the "Cool" indicator light comes on.

Press the ADJUST buttons UP ( ^ /+) or DOWN ( v /-) to select your desired room temperature.

The temperature can be set within a range of 16°C-30°C/60°F-86°F(or 88°F).

Press the "FAN SPEED" button to choose the fan speed.

## 12. FAN Mode

To turn on Fan mode, press the "MODE" button until the "Fan" indicator light comes on.

### ☀HEAT operation(cooling only models without)

- Press the "MODE" button until the "HEAT" indicator light comes on.
- Press the ADJUST buttons UP and DOWN to select your desired room temperature. The temperature can be set within a range of 16°C-30°C/60°F-86°F.
- Press the FAN button to choose the fan speed. Note: For some models, the fan speed can not be adjusted under HEAT mode.

## 13. ComfortSense

To activate the ComfortSense feature, point the remote control towards the unit and press the ComfortSense button. The remote's display will show actual temperature at its location and must be within 26 feet of the air conditioner to work. The remote control will send this signal to the air conditioner every 3 minutes until the ComfortSense button is pressed again. If the unit does not receive the ComfortSense signal during any 7 minute interval, the unit will beep to indicate the ComfortSense mode has ended.

## Drainage Guide

During dehumidifying mode, remove the upper drain plug from the back of the unit, install the drain connector (5/8" universal female mender) with 3/4" hose (not included).

For the models without drain connector, just attach the drain hose to the hole. Place the open end of the hose directly over the drain area in your basement floor. During heat pump mode(only on some models), remove the lower drain plug from the back of the unit, install the drain connector (5/8" universal female mender) with 3/4" hose (not included).

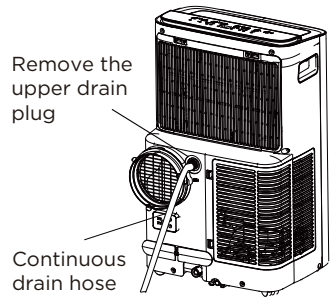

### NOTICE

Make sure the hose is secure so there are no leaks. Direct the hose toward the drain, making sure that there are no kinks that will stop the water flowing. Place the end of the hose into the drain and make sure the end of the hose is down to let the water flow smoothly. When the continuous drain hose is not used, ensure that the corresponding drain plug and knob are installed firmly to prevent leakage.

During heat pump mode(only on some models), remove the lower drain plug from the back of the unit, install the drain connector (5/8" universal female mender) with 3/4" hose (not included).

Carefully move the unit to a drain location, and let the water drain away.

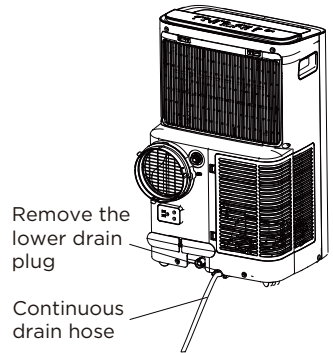

### NOTICE

Make sure the drain hose is lower than the bottom tray drain outlet.

When the water level of the bottom tray reaches a predetermined level, the unit beeps 8 times, the digital display area shows "P1". At this time the air conditioning/dehumidification process will immediately stop. However, the fan motor will continue to operate (this is normal).

Carefully move the unit to a drain location, remove the bottom drain plug and let the water drain away. Reinstall the bottom drain plug and restart the machine until the "P1" symbol disappears. If the error repeats, call for service.

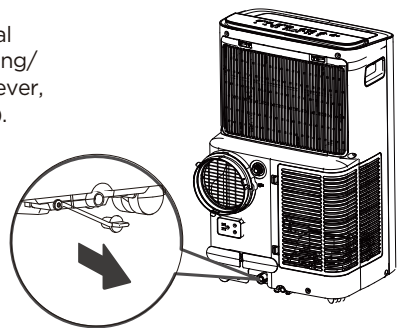

### NOTICE

Be sure to reinstall the bottom drain plug firmly to prevent leakage before using the unit.

# CLEANING & MAINTENANCE

## Air Filter & Cabinet Cleaning

Clean the unit using a damp, lint-free cloth and mild detergent.

Dry the unit with a dry, lint-free cloth.

- Take the filter out along the arrow direction.
- Wash the air filter by immersing it gently in warm water (about 40°C/104°F) with a neutral detergent.
- Rinse the filter and dry it in a shady place.
- Install the air filter after cleaning.

### CAUTION

DO NOT operate the unit without filter because dirt and lint will clog it and reduce performance.

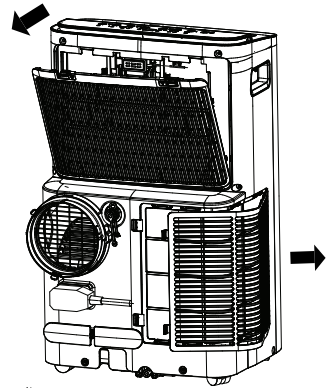

Remove the air filter

## Maintenance Tips

- Be sure to clean the air filter every 2 weeks for optimal performance.
- The water collection tray should be drained immediately after P1 error occurs, and before storage to prevent mold.
- In households with animals, you will have to periodically wipe down the grill to prevent blocked airflow due to animal hair.

### CAUTION

- Always unplug the unit before cleaning or servicing.
- DO NOT use flammable liquids or chemicals to clean the unit.
- DO NOT wash the unit under running water. Doing so causes electrical danger.
- DO NOT operate the machine if the power supply was damaged during cleaning. A damaged power cord must be replaced with a new cord from the manufacturer.

## Store The Unit When Not In Use

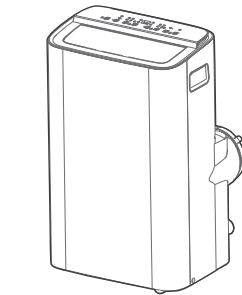
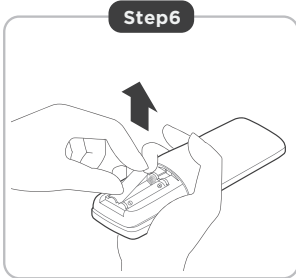
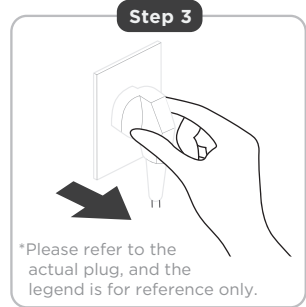
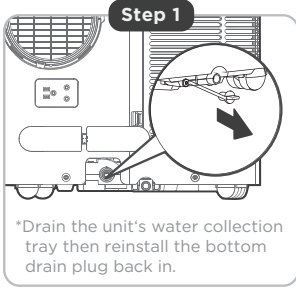

Step 1: Drain the unit's water collection tray according to the instructions on page 20.

Step 2: Run the appliance on FAN mode for 12 hours in a warm room to dry it and prevent mold.

Step 3: Turn off the appliance and unplug it.

Step 4: Clean the machine.

Step 5: Clean the air filter according to the instructions in the previous section. Reinstall the clean, dry filter before storing.

Step 6: Remove the batteries from the remote control.

### NOTICE

- Be sure to store the unit in a cool, dark place. Exposure to direct sunshine or extreme heat can shorten the lifespan of the unit.
- The cabinet and front may be dusted with an oil-free cloth or washed with a cloth dampened in a solution of warm water and mild liquid dishwashing detergent. Rinse thoroughly and wipe dry. Never use harsh cleansers, wax or polish on the cabinet front. Be sure to wring excess water from the cloth before wiping around the controls. Excess water in or around the controls may cause damage to the unit.

# TROUBLESHOOTING TIPS

## Common Issues

The following problems are not a malfunction and in most situations will not require repairs.

Proble	Solution	
Unit does not turn on when pressing ON/OFF button	P1 Protection Code.	The water collection tray is full. Turn off the unit, drain the water from the Water Collection Tray and restart the unit.
	In COOL mode: room temperature is lower than the set temperature.	Check the set temperature.
Unit does not cool well	The air filter is blocked with dust or animal hair.	Turn off the unit and clean the filter according to instructions.
	Exhaust hose is not connected or is blocked.	Turn off the unit, disconnect the hose, check for blockage and reconnect the hose.
	The unit is low on refrigerant.	Call a service technician to inspect the unit and top off refrigerant.
	Temperature setting is too high.	Decrease the set temperature.
	The windows and doors in the room are open.	Make sure all windows and doors are closed.
	The room area is too large.	Double-check the cooling area.
	There are heat sources inside the room.	Remove the heat sources if possible.
The unit is noisy and vibrates too much	The ground is not level	Place the unit on a flat, level surface.
	The air filter is blocked with dust or animal hair.	Turn off the unit and clean the filter according to instructions.
The unit makes a gurgling sound	This sound is caused by the refrigerant flow inside the unit.	This is normal.

# REMOTE CONTROL AND APP INSTRUCTIONS

## Handling the Remote Control

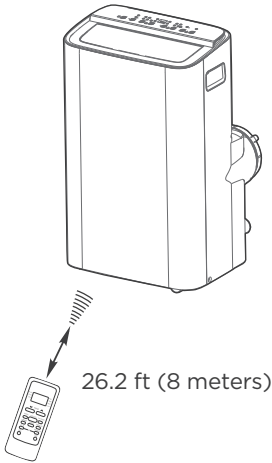

### Location of the remote control

Use the remote controller within a distance of 26.2 ft (8 meters) from the air conditioner, pointing it towards the receiver. Reception is confirmed by a beep.

### ⚠ CAUTION

- The air conditioner will not operate if curtains, doors or other materials block the signals from the remote control to the unit.
- Prevent any liquid from spilling onto the remote control. Do not expose the remote control to direct sunlight or heat.
- If the infrared signal receiver on the indoor unit is exposed to direct sunlight, the air conditioner may not function properly. Use curtains to prevent the sunlight from falling on the receiver.
- If other electrical appliances react to the remote control, either move these appliances or consult your local dealer.

### NOTICE

- Button design is based on typical model and may vary slightly from the actual one you purchased.
- All the functions described are accomplished by the unit. If the unit is without a feature, the unit will not respond if the corresponding button on the remote is pressed.
- When there are significant differences between features or operation implied by the remote control illustration and the actual functions described in the USER'S MANUAL, the descriptions in the USER'S MANUAL shall prevail.

<b>Model</b>	RG51F2(2)/CEFU1 / RG51F2(2)/EFU1
<b>Rated Voltage</b>	3.0V( Dry batteries R03/LR03×2)
<b>Signal Receiving Range</b>	8m
<b>Environment</b>	-5°C-60°C(23°F-140°F)



## Buttons and Functions

Before you begin using your new air conditioner, make sure to familiarize yourself with its remote control. The following is a brief introduction to the remote control itself. For instructions on how to operate your air conditioner, refer to the **How to Use Basic Functions** section of this manual.

### TEMP

Decreases temperature in 1°C/1°F increments.  
Min. temperature is 16°C/60°F.

### ON/OFF

Turns the unit on or off.

### MODE

Scrolls through operation modes as follows:

**AUTO** → **COOL** → **DRY** → **HEAT** → **FAN**

### SWING

Starts and stops the horizontal louver movement. Hold down for 2 seconds to initiate vertical louver auto swing feature (some units).

### C-SENSE

Temperature sensing and room temperature display button.

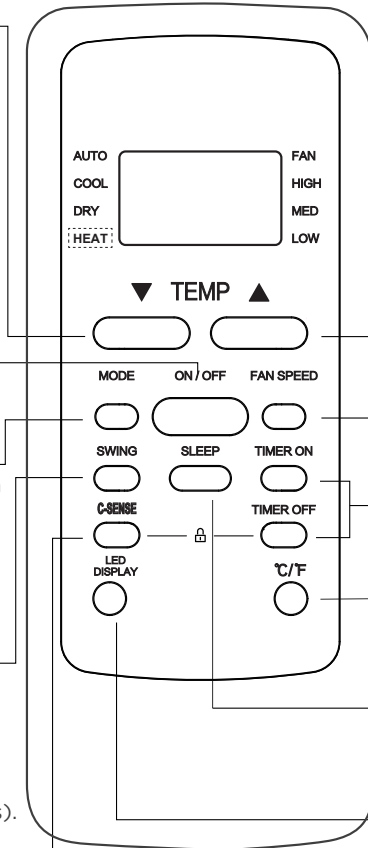

### TEMP

Increases temperature in 1°C/1°F increments.  
Max. temperature is 30°C/86°F.

### SPEED

Selects fan speeds in the following order:  
**AUTO** → **LOW** → **MED** → **HIGH**

### TIMER

Sets timer to turn unit on (see **How to Use Basic Functions** for instructions).

Sets timer to turn unit off (see **How to Use Basic Functions** for instructions).

### °C/°F

Press this button to alternate the temperature display between the °C & °F.

### SLEEP

Saves energy during sleeping hours.

### LED DISPLAY

Press this button to turn on and turn off the display on the indoor unit.

**NOTE:** Press together the two buttons simultaneously for 5 seconds to lock the keyboard. Press together the two buttons for 2 seconds to unlock the keyboard.



Press together simultaneously

Model: RG51F2(2)/EFU1  
Model: RG51F2(2)/CEFU1

## Remote Screen Indicators

Information are displayed when the remote controller is power up.

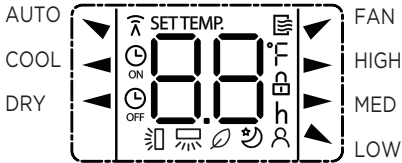

### Mode display

AUTO ▼ COOL ◀ DRY ◀  
 ▼ FAN

---

Displayed when data transmitted.  
 Displayed when remote controller is ON.

Displayed when TIMER ON time is set

Displayed when TIMER OFF time is set

Shows set temperature or room temperature, or time under TIMER setting

Indicated all the current settings are locked

Displayed when C-SENSE feature is activated(some units)

Displayed when SLEEP feature is activated

Fresh feature display

Horizontal louver swing display

Vertical louver auto swing display

### Fan speed indication

▶ HIGH High speed  
 ▶ MED Medium speed(some units)

▶ LOW Low speed

NO display Auto fan speed

### Note:

All indicators shown in the figure are for the purpose of clear presentation. But during the actual operation, only the relative function signs are shown on the display window.

## How to Use Basic Functions

**! ATTENTION** Before operation, please ensure the unit is plugged in and power is available.

### AUTO Mode

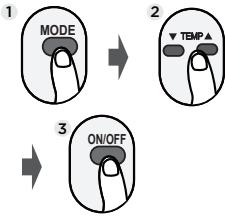

1. Select AUTO mode
2. Set your desired temperature
3. Turn on the air conditioner

**NOTE:**

1. In AUTO mode, the unit will automatically select the COOL, or FAN function based on the set temperature.
2. In AUTO mode, fan speed can not be set.

### COOL Mode

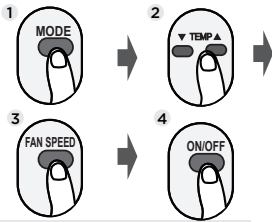

1. Select COOL mode
2. Set the temperature
3. Set the fan speed
4. Turn on the air conditioner

### DRY Mode

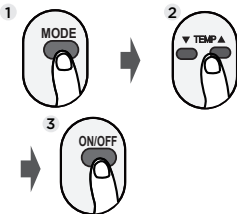

1. Select DRY mode
2. Set your desired temperature
3. Turn on the air conditioner

**NOTE:** In DRY mode, fan speed can not be set since it has already been automatically controlled.

### FAN Mode

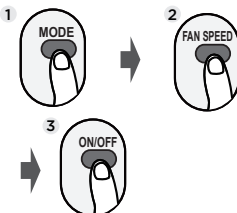

1. Select FAN mode
2. Set the fan speed
3. Turn on the air conditioner

**NOTE:** In FAN mode, you can't set the temperature. As a result, no temperature displays in remote screen.

## Setting the TIMER

**TIMER ON/OFF** - Set the amount of time after which the unit will automatically turn on/off.

### TIMER ON setting

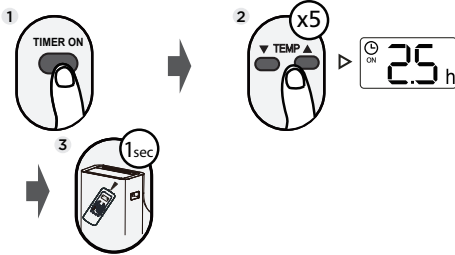

1. Press TIMER ON button to initiate the ON time sequence.
2. Press Temp. up or down button for for multiple times to set the desired time to turn on the unit.
3. Point remote to unit and wait 1sec, the TIMER ON will be activated.

### TIMER OFF setting

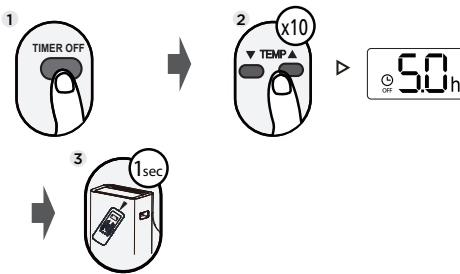

1. Press TIMER OFF button to initiate the OFF time sequence.
2. Press Temp. up or down button for multiple times to set the desired time to turn off the unit.
3. Point remote to unit and wait 1sec, the TIMER OFF will be activated.

#### NOTE:

1. When setting the TIMER ON or TIMER OFF, the time will increase by 30 minutes increments with each press, up to 10 hours. After 10 hours and up to 24, it will increase in 1 hour increments. (For example, press 5 times to get 2.5h, and press 10 times to get 5h,) The timer will revert to 0.0 after 24.
2. Cancel either function by setting its timer to 0.0h.

### TIMER ON & OFF setting(example)

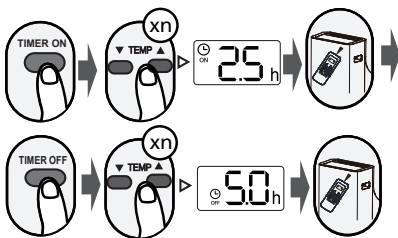

Keep in mind that the time periods you set for both functions refer to hours after the current time.

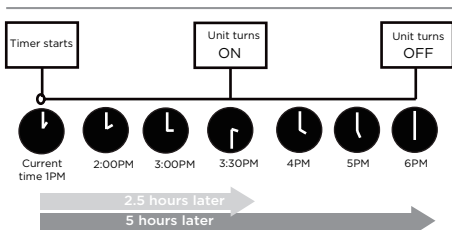

Example: If current timer is 1:00PM, to set the timer as above steps, the unit will turn on 2.5h later (3:30PM) and turn off at 6:00PM.

## How to Use Advanced Functions

### Swing function(some units)

Press Swing button

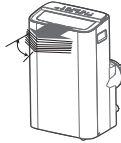

The horizontal louver will swing up and down automatically when pressing Swing button. Press again to make it stop.



Keep pressing this button more than 2 seconds, the vertical louver swing function is activated. (Model dependent)

### SLEEP function



The SLEEP function is used to decrease energy use while you sleep (and don't need the same temperature settings to stay comfortable). This function can only be activated via remote control.

The sleep function is not available in Fan or Dry mode. Please refer to the OWNER'S MANUAL for more details.

### C-SENSE function(some units)



When the C-SENSE function is activated, the remote display is actual temperature at its location.

The remote control will send this signal to the air conditioner every 3 minutes interval until press the C-SENSE button again.

**NOTE:** Press this button for seven seconds to start/stop memory feature of C-SENSE function.

- If the memory feature is activated, " **On** " displays for 3 seconds on the screen.
- If the memory feature is stopped, " **OF** " displays for 3 seconds on the screen.
- While the memory feature is activated, press the ON/OFF button, shift the mode or power failure will not cancel the C-SENSE function.

## NOTES

- Button design is based on a typical model and may slightly vary from the actual one you purchased.
- This device complies with part 15 of the FCC Rules. Operation is subject to the following two conditions: (1) This device may not cause harmful interference, and (2) this device must accept any interference received, including interference that may cause undesired operation.
- This equipment has been tested and found to comply with the limits for a Class B digital device, pursuant to part 15 of the FCC Rules. These limits are designed to provide reasonable protection against harmful interference in a residential installation. This equipment generates, uses and can radiate radio frequency energy and, if not installed and used in accordance with the instructions, may cause harmful interference to radio communications. However, there is no guarantee that interference will not occur in a particular installation. If this equipment does cause harmful interference to radio or television reception, which can be determined by turning the equipment off and on, the user is encouraged to try to correct the interference by one or more of the following measures:
  - Reorient or relocate the receiving antenna.
  - Increase the separation between the equipment and receiver.
  - Connect the equipment to an outlet on a circuit different from that to which the receiver is connected.
  - Consult the dealer or an experienced radio/TV technician for help.
  - Changes or modifications not approved by the party responsible for compliance could void users authority to operate the equipment.

### **Battery Warning:**

Do not mix old and new batteries and Do not mix alkaline, standard (carbon-zinc) or rechargeable (ni-cad, ni-mh, etc.) batteries

### **Supplier's Declaration of Conformity 47 CFR § 2.1077 Compliance Information**

**Unique Identifier:** Midea brand, RG51F2(2)/CEFU1 / RG51F2(2)/EFU1

#### **Responsible Party U.S. Contact Information**

Midea America Corporation  
300 Kimball Dr  
Parsippany NJ  
07054

Telephone number or internet contact information: Midea.com/us

#### **FCC Compliance Statement** ( products subject to Part 15)

This device complies with Part 15 of the FCC Rules. Operation is subject to the following two conditions: (1) This device may not cause harmful interference, and (2) this device must accept any interference received, including interference that may cause undesired operation.

## Declaration of Conformity

We hereby declare that this AC is in compliance with the essential requirements and other relevant provisions of Directive 1999/5/EC.

## Specification of Wireless Module

<b>Model:</b> US-SK109	<b>Dimensions:</b> 41 x 24 x 5 (mm)
<b>Antenna Type:</b> Printed PCB Antenna	<b>Operation Temperature:</b> 0°C ~ 45°C / 32°F ~ 113°F
<b>Frequency:</b> WLAN 2400-2483.5 MHz	<b>Operation Humidity:</b> 10% ~ 85%
<b>Maximum Transmitted Power:</b> <20 dBm Max	<b>Power Input:</b> DC 5V/500 mA

## PRECAUTIONS

1. Supports operating systems: Please refer to page 37.
2. In the event of a OS update, there may be a delay between the update of the OS and a related software update during which your OS may or may not be supported until a new version is released. Your specific mobile phone or problems in your network may prevent the system from working and Midea will not be responsible for any problems that could be caused by incompatibility or network issues.
3. This Smart AC only supports WPA-PSK/WPA2-PSK (recommended) encryption.
4. To ensure proper scanning of the QR code, your smart phone must have at least a 5-megapixel camera.
5. Due to unstable network connectivity, requests may time out. If this happens, rerun the network configuration.
6. Due to unstable network connectivity, commands may time out. If this happens, the smartphone app and the actual product may display conflicting information. The information displayed on the actual product is always the most accurate available. Refresh the app to re-sync.

## NOTICE

Midea will not be responsible for any problems that could be caused by incompatibility or network issues, your wireless router and mobile phone.

# 1 How to use SmartHome App

- ⚠ Ensure that your mobile phone is connected to the wireless network. Bluetooth must be turned on.  
The device must also be powered up.

## ■ Step 1: Download the SmartHome app

Scan the QR code below to download the SmartHome app from app store or search for it directly on the Google Play Store or Apple's App Store.



## ■ Step 2: Log in

Open the SmartHome app. Log in directly if you have an existing SmartHome account or create a new account. Alternatively, you can also use a 3rd party login platform.

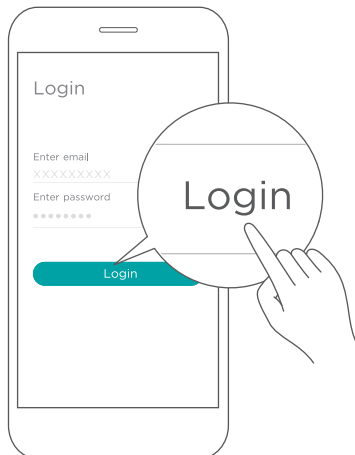



### ■ Step 3: Connecting the device

1) When you log in, you may see the message "Smart devices discovered nearby". Tap to add your device.

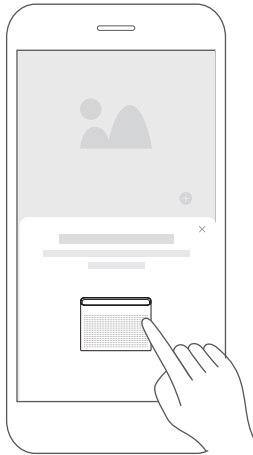

2) If no such message appears, proceed as follows: Tap on "+" and select your device in the list of nearby available devices. If your device is not listed, please add your device manually, first selecting the device category e.g. Window AC.

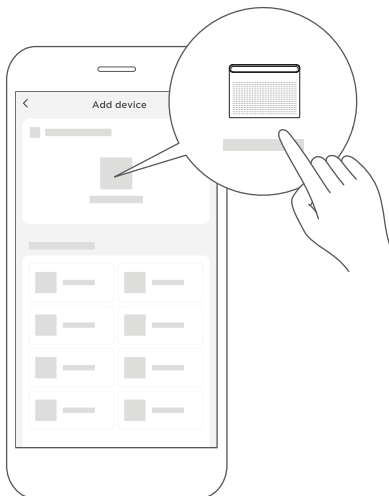

3) Follow the steps in the app to connect your device to the wireless network. If your device fails to connect, follow the additional instructions in the app.

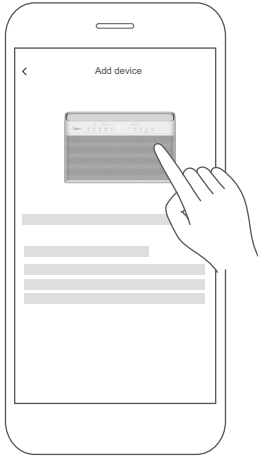

For Window AC



For Portable AC

#### ■ Step 4: Controlling the device

After pairing successfully, a card will be created for the device in the SmartHome app. Shortcuts for basic functions will appear on the card such as changing the temperature or switching the device on or off.

Tapping on the card, will reveal additional features and settings. The actual UI design may look different from examples due to app updates.

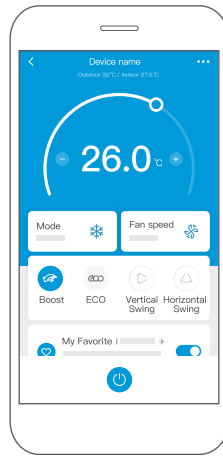
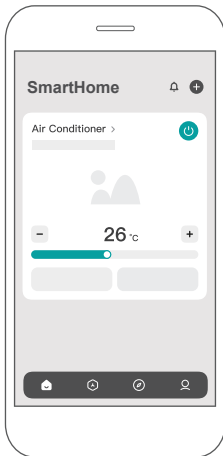

## 2 How to use Matter

Matter is a connectivity technology that unifies the smart home by allowing devices and ecosystems (such as Alexa, Google Home and Apple Home) to speak the same language thus creating exciting new features and use cases.

To use Matter, you will need at least one Matter enabled smart speaker from Amazon, Google or Apple, and it's respective app.

-- If you have a Matter enabled smart speaker, please proceed to the "How to use Matter" instructions on the following pages.

-- If you don't have a Matter enabled smart speaker, you won't be able to use Matter right now. However, you can still achieve full functionality of the product by using our SmartHome app. To do this, proceed to the "How to use SmartHome app" section back on page 30.

### Connect Your Air Conditioner through Matter

⚠ Make sure your mobile device is connected to your wireless router.

Wireless router should support and turn on IPv6. Please make sure your smartphone connects to 2.4G but not 5G network.

For best Matter compatibility, connect the AC to the Alexa, Google Home or Apple Home ecosystems along with at least one of their respective Matter enabled smart speakers.

#### ■ Step 1: Connect to smart speaker

Select your preferred ecosystem (Alexa, Google Home or Apple Home) and make sure you've got one of their Matter enabled products (such as their smart speakers) connected to your wireless router.

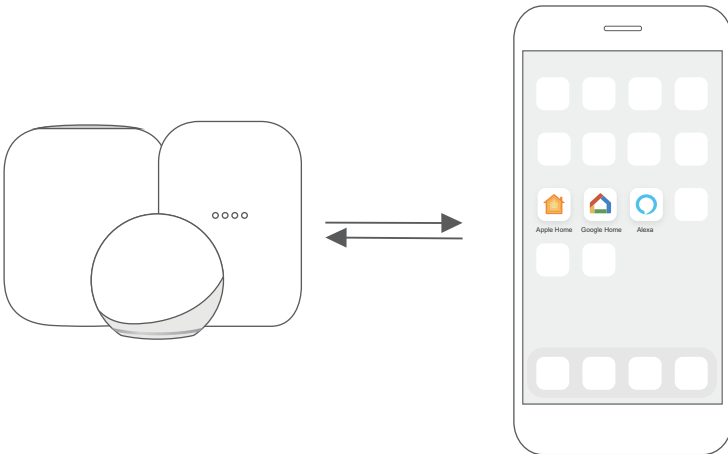

■ **Step 2: Turn on Bluetooth**

Turn on Bluetooth on your mobile device.

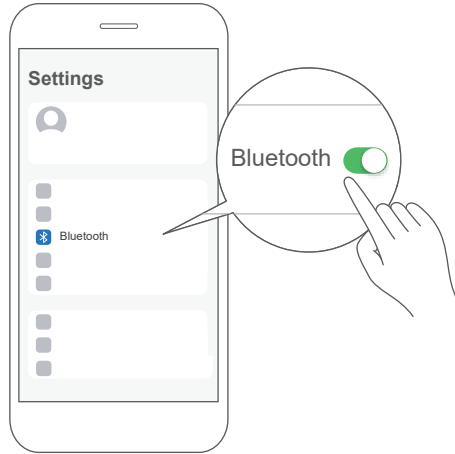

■ **Step 3: Enter AP mode**

Window AC: Hold down the CONNECT / Power button for 3 seconds to begin the pairing process ("AP" will appear on the AC's display).

Portable AC: Hold down the SWING / Power button for 3 seconds to begin the pairing process ("AP" will appear on the AC's display).

Note: Entering AP pairing mode may vary between different AC, please follow instruction of AC panel.

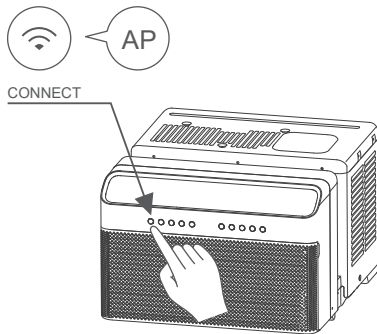

Window AC

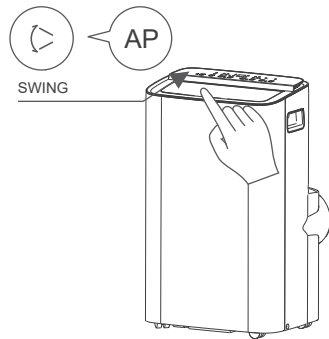

Portable AC

■ **Step 4: Open app**

Open the Alexa, Google Home, Apple Home app on your mobile device.

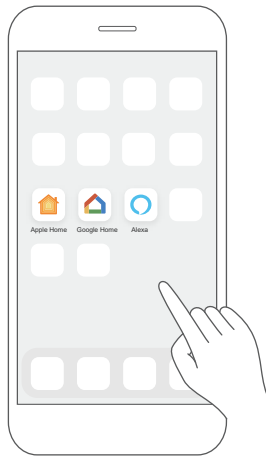

■ **Step 5: Scan matter QR code**

Tap the “+” and “Add Device/Accessory” or tap “+Add” in your app and then select Matter device and scan the Matter QR code found on the side of the AC device. Follow the respective instructions in the Alexa, Google Home or Apple Home app to complete the pairing process.

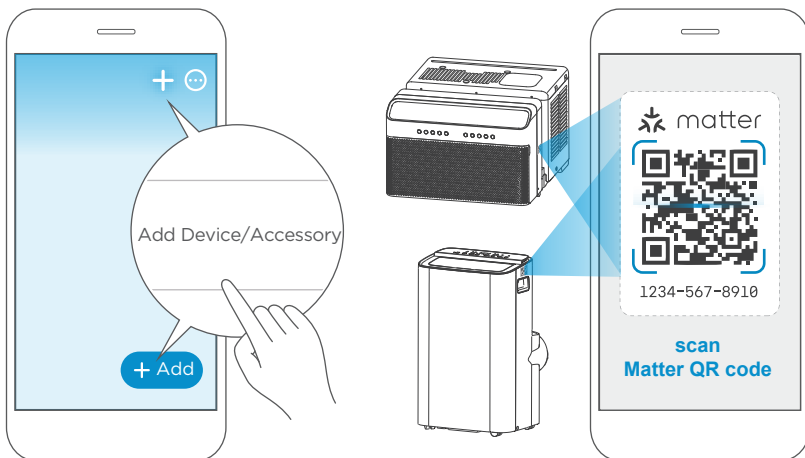

## ■ Step 6: Control device

After pairing is successful, you can control your AC's temperature and mode settings, etc. through the respective ecosystem app and smart speaker.

Due to a compatibility issue, the temperature value shown in the Alexa, Google Home or Apple Home app may be 1 degree different from that displayed on the air conditioner. However, this will not impact the device's ability to cool the room.



**App & Smart Speakers can support Matter only when using these versions or above.**

Device	Version
iPhone	iOS 16.5
Apple Home Pod	16.5
Android	Google Play services min version: 22.36.15 Google Home app (GHA) min version: 2.58.24.1-dogfood
Google Home Hub	Google Hub firmware min version: 1.56.324896 (appears on hub as Chromecast firmware version)
Alexa App	2.2.536317
Alexa Echo Device	9094439556

**NOTE:**

- Setup processes and features may vary between ecosystems.
- The functions shown in the Alexa, Google Home or Apple Home apps may change with updates to their products or apps.
- Make sure the Matter enabled app is up to date to ensure the best experience.
- Periodically, we will update the device’s software to improve the experience. Device software updates can be accomplished through the SmartHome app.
-  matter is developed by the Connectivity Standards Alliance TM. This brand, related logos, and marks are trademarks of the Alliance, all rights reserved.
- Use of the Works with Apple badge means that an accessory has been designed to work specifically with the technology identified in the badge and has been certified by the developer to meet Apple’s performance standards. Apple is not responsible for the operation of this device or its compliance with safety and regulatory standards.

## ■ Declaration of conformity

**FCC ID: 2ADQOMDNA23**

**IC: 12575A-MDNA23**

This device complies with Part 15 of the FCC Rules and Industry Canada's licence exempt RSSs.

Operation is subject to the following two conditions:

- (1) This device may not cause interference; and
- (2) This device must accept any interference, including interference that may cause undesired operation of the device.

Only operate the device in accordance with the instructions supplied. Changes or modifications to this unit not expressly approved by the party responsible for compliance could void the user's authority to operate the equipment. This device complies with FCC radiation exposure limits set forth for an uncontrolled environment. In order to avoid the possibility of exceeding the FCC radio frequency exposure limits, human proximity to the antenna shall not be less than 20cm (8 inches) during normal operation.

### **NOTE:**

This equipment has been tested and found to comply with the limits for a Class B digital device, pursuant to part 15 of the FCC Rules. These limits are designed to provide reasonable protection against harmful interference in a residential installation. This equipment generates, uses and can radiate radio frequency energy and, if not installed and used in accordance with the instructions, may cause harmful interference to radio communications. However, there is no guarantee that interference will not occur in a particular installation. If this equipment does cause harmful interference to radio or television reception, which can be determined by turning the equipment off and on, the user is encouraged to try to correct the interference by one or more of the following measures:

- Reorient or relocate the receiving antenna.
- Increase the separation between the equipment and receiver.
- Connect the equipment into an outlet on a circuit different from that to which the receiver is connected.
- Consult the dealer or an experienced radio/TV technician for help.

Hereby, we declare that this AC is in compliance with the essential requirements and other relevant provisions of RE Directive 2014/53/EU. A copy of the full DoC is attached (European Union products only).



# WARRANTY

## Air Conditioner Limited Warranty

Your product is protected by this Limited Warranty:

Warranty service must be obtained from Midea Consumer Services or an authorized Midea servicer.

---

### Warranty

- 1 Year Full Warranty from original purchase date.

### Midea, through its authorized servicers will:

- Pay all costs for repairing or replacing parts of this appliance which prove to be defective in materials or workmanship.

### Consumer will be responsible for:

- Diagnostics, removal, transportation and reinstallation cost required because of service.
- Costs of service calls that are a result of items listed under NORMAL RESPONSABILITIES OF THE CONSUMER\*\*

Midea replacement parts shall be used and will be warranted only for the original warranty.

---

### NORMAL RESPONSABILITIES OF THE CONSUMER\*\*

**This warranty applies only to products in ordinary household use, and the consumer is responsible for the items listed below:**

1. Proper use of the appliance in accordance with instructions provided with the product.
2. Routine maintenance and cleaning necessary to keep the good working condition.
3. Proper installation by an authorized service professional in accordance with instructions provided with the appliance and in accordance with all local plumbing, electrical and/or gas codes.
4. Proper connection to a grounded power supply of sufficient voltage, replacement of blown fuses, repair of loosen connections or defects in house wiring.
5. Expenses for making the appliance accessible for servicing.
6. Damages to finish after installation.

### EXCLUSIONS

**This warranty does not cover the following:**

- 1) Failure caused by damage to the unit while in your possession (other than damage caused by defect or malfunction), by its improper installation, or by unreasonable use of the unit, including without limitation, failure to provide reasonable and necessary maintenance or to follow the written Installation and Operating Instructions.
- 2) Damages caused by serviced performed by persons other than those authorized by Midea customer service; or external causes such as abuse, misuse, inadequate power supply or acts of God.
- 3) If the unit is put to commercial, business, rental, or other use or application other than for consumer use, we make no warranties, express or implied, including but not limited to, any implied warranty of merchantability or fitness for use or purpose.
- 4) Products without original serial numbers or products that have serial numbers which have been altered or cannot be readily determined.

**NOTICE: Some states do not allow the exclusions or limitation of incidental or consequential damages. So this limitation or exclusion may not apply to you.**

### IF YOU NEED SERVICE

Keep your bill of sale, delivery slip, or some other appropriate payment Record.

The date on the bill establishes the warranty period, should service be required.

If service is performed, it's your best interest to obtain and keep all receipts.

This written warranty gives you specific legal rights. You may also have other rights that vary from state to state.

Service under this warranty must be obtained by following these steps, in order:

- 1) Contact Midea Consumer Services or an authorized Midea services at 1 866 646 4332.
- 2) If there is a question as to where to obtain service, contact our consumer relations Department.







*make yourself at home*



[www.midea.com](http://www.midea.com)

© Midea 2023 all rights reserved

CP001UI-PX

16120600A27479

20231226