

PORTABLE AIR CONDITIONER

USER MANUAL

MAP08S1JWT-B
MAP10V1JWT-B

Before using this product, please read this manual carefully and keep it for future reference. The design and specifications are subject to change without prior notice for product improvement. Consult with your dealer or the manufacturer for details.

THANK YOU LETTER

Thank you for choosing Midea! Before using your new Midea product, please read this manual thoroughly to ensure that you know how to operate the features and functions that your new appliance offers in a safe way.

CONTENTS

THANK YOU LETTER	2
SAFETY PRECAUTIONS	3
BEFORE YOU GET STARTED	8
INSTALLATION INSTRUCTIONS	10
OPERATING INSTRUCTIONS	18
CLEANING & MAINTENANCE	21
TROUBLESHOOTING TIPS	23
REMOTE CONTROL AND APP INSTRUCTIONS	24

Read This Manual

Inside you'll find many helpful hints on how to use and maintain your air conditioner properly. Just a little preventative care on your part can save you a great deal of time and money over the life of your air conditioner. You'll find many answers to common problems in the troubleshooting tips - you should be able to fix most of them quickly before calling service. These instructions may not cover every possible condition of use, so common sense and attention to safety is required when installing, operating and maintaining this product.



CAUTION

- For support, please call the Service Center at 1-866-646-4332.
- This appliance is not intended for use by people (including children) with reduced physical, sensory or mental capabilities or lack of experience and knowledge, unless they have been given supervision or instruction concerning use of the appliance by a person responsible for their safety.
- Children should be supervised to ensure that they do not play with the air conditioner.
- The appliance shall be installed in accordance with national wiring regulations.
- Do not operate your air conditioner in a humid room such as a bathroom or laundry room.

SAFETY PRECAUTIONS

Must Read the Warning Message

Read Safety Precautions Before Operation and Installation.

To prevent property damage, injury or death to user or other people, the instructions in this manual must be followed. Incorrect operation due to ignoring of instructions may cause damage, harm, or death.

The level of risk is shown by the following indications.



WARNING

This symbol indicates a hazardous situation which, if not avoided, could result in death or serious injury.



CAUTION

This symbol indicates a hazardous situation, which, if not avoided, could result in minor or moderate injury.

NOTICE

This symbol addresses practices not related to physical injury.



WARNING

- Installation must be performed according to the installation instructions. Improper installation can cause water leakage, electrical shock, or fire.
- Use only the included accessories and parts, and specified tools for the installation. Using nonstandard parts can cause water leakage, electrical shock, fire, and injury or property damage.
- Make sure that the outlet you are using is grounded and has the appropriate voltage. The power cord is equipped with a three-prong grounding plug to protect against shock. Voltage information can be found on the nameplate of the unit.
- Your unit must be used in a properly grounded wall receptacle. If the wall receptacle you intend to use is not adequately grounded or protected by a time delay fuse or circuit breaker, have a qualified electrician install the proper receptacle (the fuse or circuit breaker needed is determined by the maximum current of the unit. The maximum current is indicated on the nameplate located on unit).
- Do not touch the unit with wet or damp hands or when barefoot.
- If the air conditioner is knocked over during use, turn off the unit and unplug it from the main power supply immediately. Visually inspect the unit to ensure there is no damage. If you suspect the unit has been damaged, contact a technician or customer service for assistance.
- In a thunderstorm, the power must be cut off to avoid damage to the machine due to lightning.
- Your air conditioner should be used in such a way that it is protected from moisture. e.g. condensation, splashed water, etc. Do not place or store your air conditioner where it can fall or be pulled into water or any other liquid. Unplug immediately if it occurs.
- Install the unit on a flat, sturdy surface. Failure to do so could result in damage or excessive noise and vibration.

WARNING

- The unit must be kept free from obstruction to ensure proper function and to mitigate safety hazards.
- Do not modify the length of the power cord or use an extension cord to power the unit.
- Do not share a single outlet with other electrical appliances. Improper power supply can cause fire or electrical shock.
- Do not install your air conditioner in a wet room such as a bathroom or laundry room. Too much exposure to water can cause electrical components to short circuit.
- Do not install the unit in a location that may be exposed to combustible gas, as this could cause fire.
- The unit has wheels to facilitate moving. Make sure not to use the wheels on thick carpet or to roll over objects, as this could cause the unit to tip over.
- Do not operate a unit that has been dropped or damaged.
- Ensure the unit remains at least 3ft (1m) away from any combustible materials such as bedding, curtains, and furniture.
- All wiring must be performed strictly in accordance with the wiring diagram located inside of the unit.
- The unit's circuit board (PCB) is designed with a fuse to provide overcurrent protection. The specifications of the fuse are printed on the circuit board, such as: T 3.15A/250V, etc.
- When the water drainage function is not in use, keep the upper and lower drain plug firmly attached. When the drain plug is not in use, keep it out of reach of children to avoid a choking hazard.

CAUTION

- This appliance is not intended for use by persons (including children) with reduced physical, sensory or mental capabilities or lack of experience and knowledge, unless they have been given supervision or instruction concerning use of the appliance by a person responsible for their safety.
- Children should be supervised to ensure that they do not play with the appliance. Children must be supervised around the unit at all times.
- If the supply cord is damaged, it must be replaced by the manufacturer, its service agent or similarly qualified persons in order to avoid a hazard.
- Do not use this product for functions other than those described in this instruction manual.
- Before cleaning, turn off the power and unplug the unit.
- Disconnect the power if strange sounds, smell, or smoke comes from it.
- Do not press the buttons on the control panel with anything other than your fingers.
- Do not remove any fixed covers. Never use this appliance if it is not working properly, or if it has been dropped or damaged.

CAUTION

- Do not operate or stop the unit by inserting or pulling out the power cord plug.
- Do not use hazardous chemicals to clean or come into contact with the unit. Do not use the unit in the presence of inflammable substances or vapour such as alcohol, insecticides, petrol, etc.
- Prior to cleaning or other maintenance, the appliance must be disconnected from the supply mains.
- Do not remove any fixed covers. Never use this appliance if it is not working properly, or if it has been dropped or damaged.
- Do not run cord under carpeting. Do not cover cord with throw rugs, runners, or similar coverings. Do not route cord under furniture or appliances. Arrange cord away from traffic area and where it will not be tripped over.
- Do not operate unit with a damaged cord, plug, power fuse or circuit breaker. Discard unit or return to an authorized service facility for examination and/or repair.
- To reduce the risk of fire or electric shock, do not use this fan with any solid-state speed control device.
- The appliance shall be installed in accordance with national wiring regulations.
- Contact the authorized service technician for repair or maintenance of this unit.
- Contact the authorized installer for installation of this unit.
- Do not cover or obstruct the inlet or outlet grilles.
- Always transport your air conditioner in a vertical position and stand on a stable, level surface during use.
- Always contact a qualified person to carry out repairs. If the damaged power supply cord must be replaced, use a new power supply cord obtained from the product manufacturer. Do not repair the damaged cord.
- Hold the plug by the head of the power plug when taking it out.
- Turn off the product when not in use.

FOR R32 REFRIGERANT MODEL



CAUTION:
Risk of fire
flammable materials

IMPORTANT NOTE: Read this manual carefully before installing or operating your new appliance. Make sure to save this manual for future reference.

Explanation of symbols displayed on the unit



CAUTION

This symbol shows that the operation manual should be read carefully.



CAUTION

This symbol shows that a service personnel should be handling this equipment with reference to the installation manual.



CAUTION

This symbol shows that information is available such as the operating manual or installation manual.

WARNING

- Servicing shall only be performed as recommended by the equipment manufacturer. Maintenance and repair requiring the assistance of other skilled personnel shall be carried out under the supervision of a person competent in the use of flammable refrigerants.
- DO NOT modify the length of the power cord or use an extension cord to power the unit.
- DO NOT share a single outlet with other electrical appliances. Improper power supply can cause fire or electrical shock.
- Please follow the instruction carefully to handle, install, clean, and service the appliance to avoid any damage or hazard.

Flammable

Refrigerant R32 is used within appliance.

- When maintaining or disposing of the appliance, the refrigerant (R32) shall be recovered properly and shall not discharge to air directly.
- Compliance with national gas regulations shall be observed.
- Keep ventilation openings clear of obstruction.
- The appliance shall be stored so as to prevent mechanical damage from occurring.
- A warning that the appliance shall be stored in a well-ventilated area where the room size corresponds to the room area as specified for operation.

WARNING

- Any person who is involved with working on or breaking into a refrigerant circuit should hold a current valid certificate from an industry-accredited assessment authority, which authorizes their competence to handle refrigerants safely in accordance with an industry recognized assessment specification.

Examples for such working procedures are:

- Breaking into the refrigerating circuit;
 - Opening of sealed components;
 - Opening of ventilated enclosures.
-
- No open fire or device like switch which may generate spark/arcing shall be around the appliance to avoid causing ignition of the flammable refrigerant used. Please follow the instruction carefully to store or maintain the appliance to prevent mechanical damage from occurring.
 - Do not use means to accelerate the defrosting process or to clean, other than those recommended by the manufacturer.
 - The appliance shall be stored in a room without continuously operating ignition sources (for example: open flames, an operating gas appliance) and ignition sources or (for example: an operating electric heater) close to the appliance.
 - Do not pierce or burn.
 - Be aware that the refrigerants may not contain an odor.

BEFORE YOU GET STARTED

Preparations Before Installation



The installation must be carried out in strict accordance with the instructions in this manual.



We recommend doing this with a helper.



Installing your AC should take about 30 minutes.



We're here if you need us, please contact 1-866-646-4332

Ambient Temperature Range For Unit Operating:

Mode	Temperature Range
Cool	16~35°C (60~95°F)
Dry	13~35°C (55~95°F)

Know your Portable Air Conditioner

Energy Rating Information

The energy rating and noise information for this unit is based on the standard installation using an un-extended exhaust duct without window slider adaptor (as shown in the Installation section of this manual). With the unit operating on COOL MODE and HIGH FAN SPEED.

How to Stay Cool with a New Portable Air Conditioner (For the models comply with the requirements of Department Of Energy in US)

Because of a new federal test procedure for Portable Air Conditioners, you may notice that the cooling capacity claims on portable air conditioner packaging are significantly lower than that of models produced prior to 2017. This is due to changes in the test procedure, not to the portable air conditioners themselves.

What Should I Look For First When Purchasing A Portable Air Conditioner?

The right air conditioner helps you cool a room efficiently. An undersized unit won't cool adequately while one that's too large will not remove enough humidity, leaving the air feeling damp. To find the proper air conditioner, determine the square footage of the room you want to cool by multiplying the room length by its width. You also need to know the air conditioner's BTU (British Thermal Unit) rating, which indicates the amount of heat it can remove from a room. A higher number means more cooling power for a larger room. (Be sure you are comparing only newer models to each other. Older models may appear to have a higher capacity, but are actually the same). Be sure to "size up" if your portable air conditioner will be placed in a very sunny room, in a kitchen, or in a room with high ceilings. After you've found the right cooling capacity for your room, you can look at other features.

Why Newer Products Have Lower Cooling Capacity Than Older Models

Federal regulations require manufacturers to calculate cooling capacity based on a specific test procedure, which was changed just this year. Models manufactured before 2017 were tested under a different procedure and cooling capacity was measured differently in prior year's models. So, while the BTUs may be lower now, the actual cooling capacity of the air conditioners has not changed.

What is SACC?

SACC is the representative value of Seasonally Adjusted Cooling Capacity, in Btu/h, as determined in accordance with the DOE test procedure at title 10 Code of Federal Regulations (CFR) 430, subpart B, appendix CC and applicable sampling plans.

INSTALLATION INSTRUCTIONS

Product Installation Location

Your Installation Location Should Meet The Following Requirements:

- Make sure that you install your unit on an even surface to minimize noise and vibration.
- The unit must be installed near a grounded plug, and the Collection Tray Drain (found on the back of the unit) must be accessible.
- The unit should be located at least 30cm (12") from the nearest wall to ensure proper air conditioning. The air outlet of the unit should be at least 50cm (19.7") away from obstacles.
- DO NOT cover the Intakes, Outlets or Remote Signal Receptor of the unit, as this could cause damage to the unit.

Unit Installation Location Restricted Space Requirements

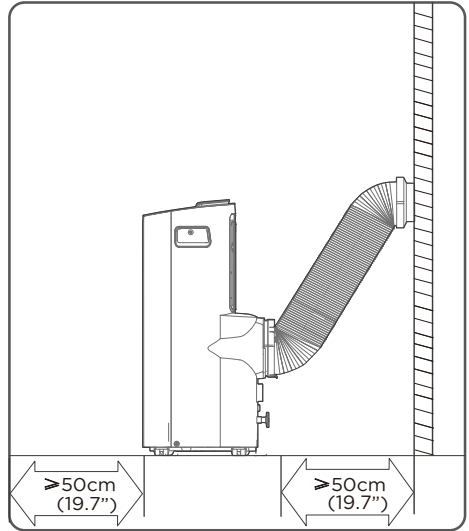
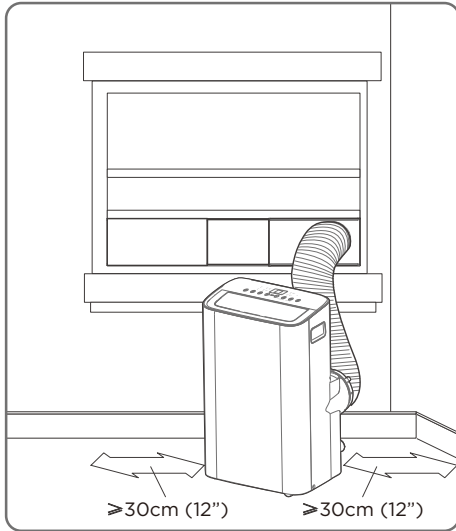

Product Overview

NOTICE

All the illustrations in the manual are for explanation purpose only. Your machine may be slightly different. The actual shape shall remain the same.

The unit can be controlled by the unit control panel alone or with the remote control.

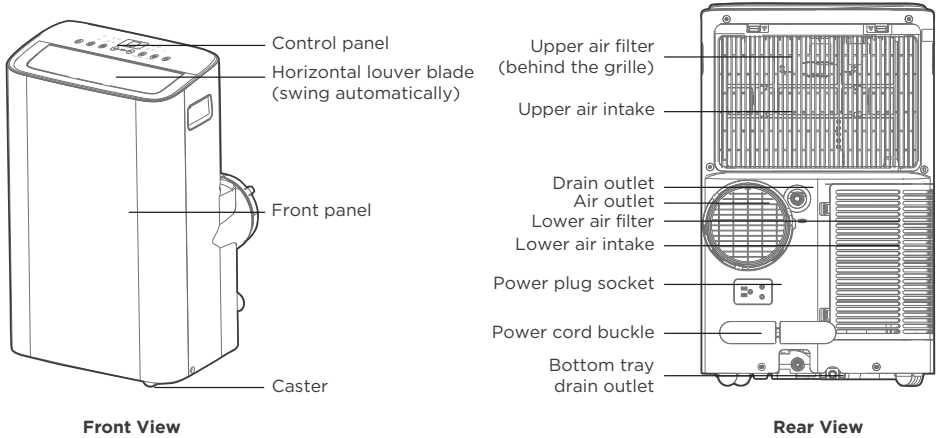

DESIGN NOTICE

In order to ensure the optimal performance of our products, the design specifications of the unit and remote control are subject to change without prior notice.

Installation Overview

Installation Completion Display

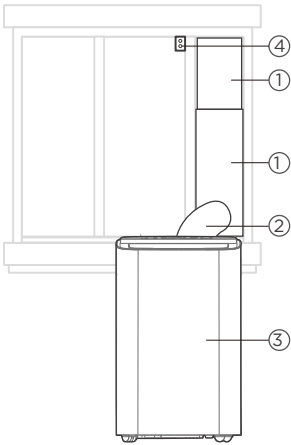

Sliding Window Installation

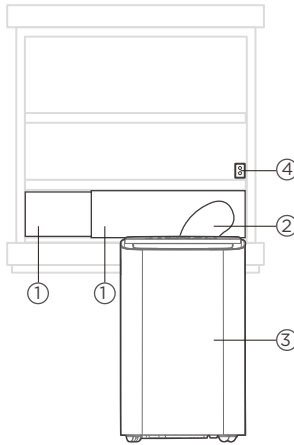

Hung Window Installation

1. Window Slider
2. Extended Exhaust Hose
3. Portable Air Conditioner
4. Security Bracket and 2 Screws

NOTICE

Illustrations in this manual are for explanatory purposes. The actual shape of your indoor unit may be slightly different. The actual shape shall prevail.

Tools Needed



Screwdriver & wrench



Pencil



A tape measure



Scissors or Knife



Saw (On some models, to shorten window adaptor for narrow windows)

Installation Accessories

Your Window Installation Kit fits windows 19.4"-62.2"(49.3-158.1cm) and can be shortened for smaller windows.

NOTICE

Items with (*) are on some models. Slight variations in design may occur.

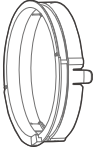

Unit Adaptor
(1pc)

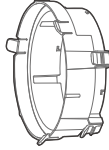

Window Slider
Adaptor (*)
(1 pc)

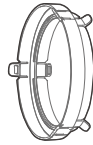

Exhaust Hose
Adaptor
(1 pc*)

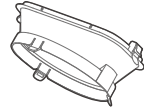

Air exhaust
passage (1 pc*)



Foam Seal A
(Adhesive) 4 pc(*)



Foam Seal B
(Adhesive) 2 pc



Foam Seal C
(Non-adhesive) 2 pc(*)



Security Bracket
and 2 Screws (1 set)



Drain Hose
(1 pc)



Exhaust Hose
(1 pc)



Bolt (3 pc)



Power Cord
Buckle (1 pc)

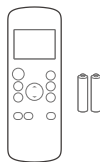

Remote Controller
and Battery
(1 set*)



Window Sliders
1 set(*)

Confirm Your Window Type (Window Type And Opening Size Of Different Types)

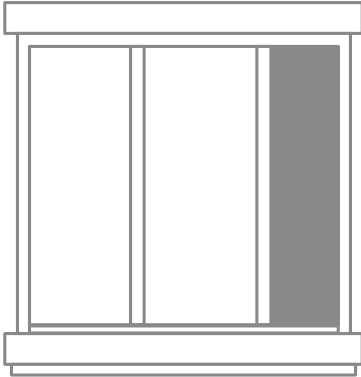

Sliding Window Installation

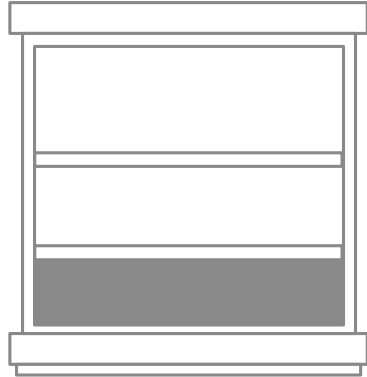

Hung Window Installation

For Optimal Performance In Operation

NOTICE

To ensure proper function, DO NOT overextend or bend the hose. Make sure that there is no obstacle around the air outlet of the exhaust hose (in the range of 500mm) in order to ensure the exhaust system works properly. All the illustrations in this manual are for explanation purpose only. Your air conditioner may be slightly different. The actual shape shall prevail.

INCORRECT

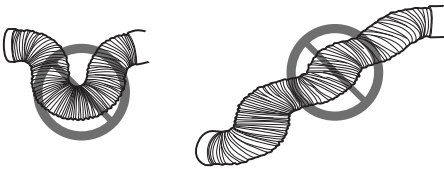

CORRECT

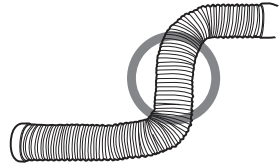

Exhaust Hose And Adaptors Installation

1 - The Exhaust Hose Assembly Installation (Window Type):

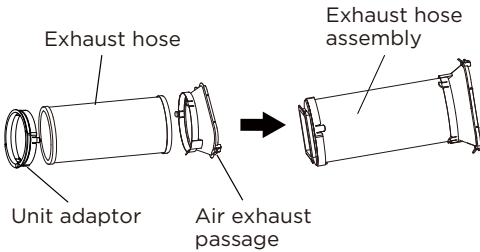

Press the exhaust hose (or extended exhaust hose) into the window slider adaptor and unit adaptor. The pieces will clip together using the tabs on the adaptors.

NOTICE

Please install the exhaust hose assembly according to the fittings in your kit.

2 - Preparing the Adjustable Window Slider:

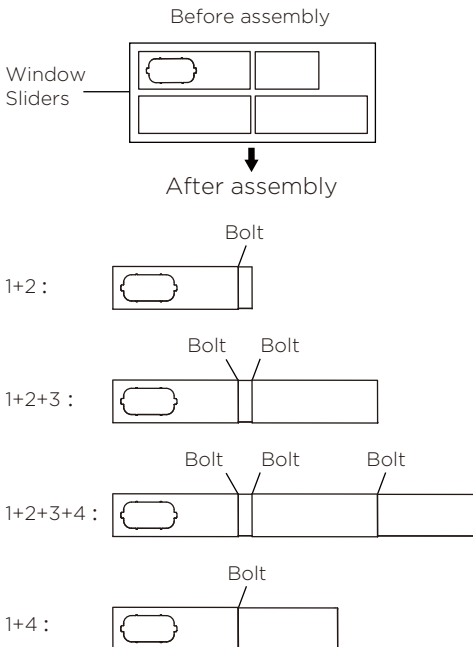

Choose the window sliders according to the size of your window. Some of the sliders may need to be cut to fit the exact window size, make sure to cut the sliders carefully if this is required.

Use bolts to fasten the window sliders once they are adjusted to the proper length.

NOTICE

Please base your window slider installation on the accessories in your kit and the size of your window.

NOTICE

Once the exhaust hose assembly and adjustable window slider are prepared, choose one of the two installation methods based on your window type.

3 - Complete Sealing of Window:

Cut the adhesive foam seal A and B strips to the proper lengths, and attach them to the window sash and frame as shown.

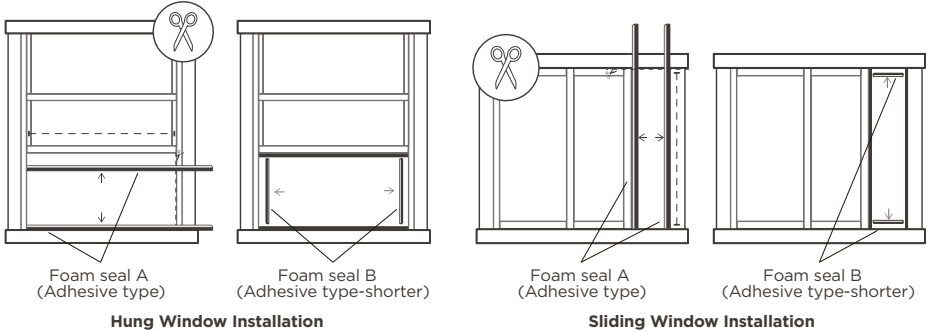

4 - Hung Window Installation:

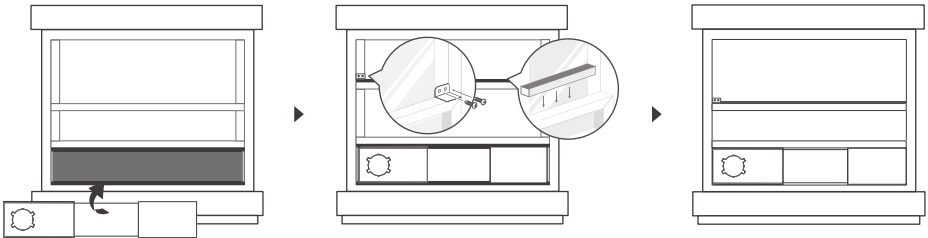

Step 1: Insert the window slider assembly into the window opening.

Step 2: Cut the non-adhesive foam seal C strip to match the width of the window. Insert the seal between the glass and the window frame to prevent air and insects from getting into the room.

Step 3: If desired, install the security bracket with 2 screws as shown.

5 - Sliding Window Installation:

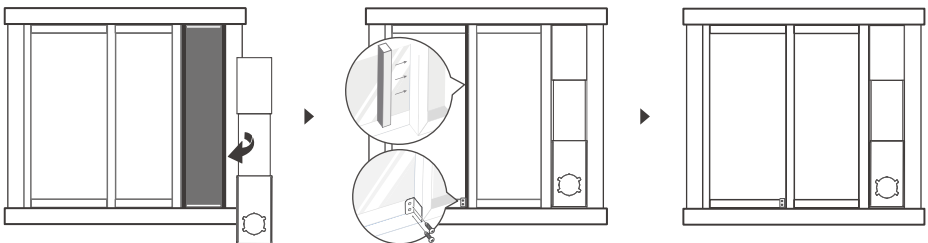

Step 1: Insert the window slider assembly into the window opening.

Step 2: Cut the non-adhesive foam seal C strip to match the height of the window. Insert the seal between the glass and the window frame to prevent air and insects from getting into the room.

Step 3: If desired, install the security bracket with 2 screws as shown.

6 - Install The Exhaust Hose Assembly To The Unit:

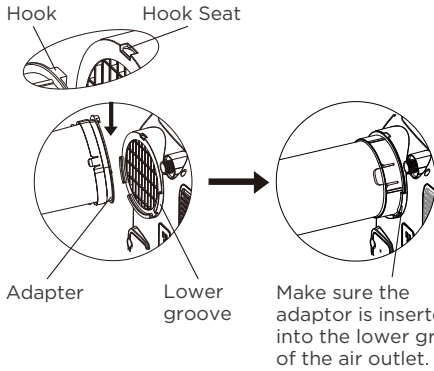

Push the exhaust hose into the air outlet opening of the unit along the arrow direction.

7 - Connect The Adaptor To The Unit And The Window:

Insert the window slider adaptor into the hole of the window slider.

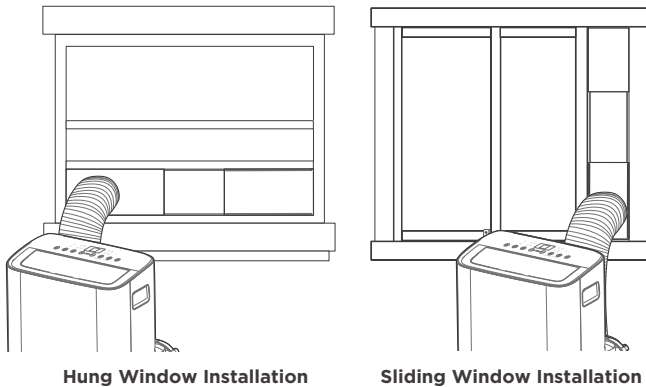

OPERATING INSTRUCTIONS

Electronic Control Operating Instructions

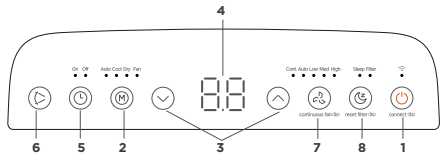
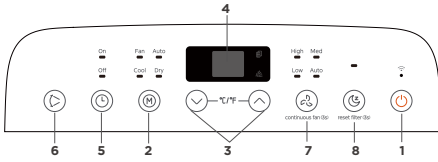

1. POWER Button

Power switch on/off .

Used to initiate the Wireless function. For the first time using the Wireless button, press and hold the POWER button for 3 seconds to initiate the Wireless connection mode. The LED DISPLAY shows 'AP' to indicate you can set Wireless connection. If connection (router) is successful within 8 minutes, the unit will exit Wireless connection mode automatically and the Wireless indicator light illuminates.

If connection fails within 8 minutes, the unit exits Wireless connection mode automatically. After Wireless connection is successful, you can press and hold POWER and DOWN (∨/-) buttons at the same time for 3 seconds to turn off wireless function and the LED display shows 'OF' for 3 seconds, press POWER and UP (∧/+) buttons at the same time to turn on Wireless function and the LED DISPLAY shows 'On' for 3 seconds.

NOTICE

When you restart the Wireless function, it may take a period of time to connect to the network automatically.

2. MODE Function

Selects the appropriate operating mode. Each time you press the button, a mode is selected in a sequence that goes from AUTO, COOL, DRY, FAN, and HEAT (heat function only on some models). The mode indicator light illuminates under the different mode settings. See page 19 for more information on each mode.

3. UP (∧/+) and DOWN (∨/-) Buttons

Used to adjust (increasing/decreasing) temperature settings in 1°C/2°F (or 1°F) increments in a range of 16°C-30°C/60°F-86°F(or 88°F).

TIMER setting in a range of 0-24hrs.

NOTICE

The control is capable of displaying temperature in degrees Fahrenheit or degrees Celsius. To convert from one to the other, press and hold the Up and Down buttons at the same time for 3 seconds.

4. DISPLAY

Shows the set temperature in °C or °F and the Auto-timer settings. While on DRY and FAN modes, it shows the room temperature.

Shows Error codes and protection code:

EH60-Room temperature sensor error.

EH61-Evaporator temperature sensor error.

EC52-Condenser temperature sensor error (on some models).

EH0b-Display panel communication error.

ELOC-Refrigerant leakage detection malfunction (on some models).

P1 - Bottom tray is full - Connect the drain hose and drain the collected water away. If protection repeats, call for service.

NOTICE

When one of the above malfunctions occurs, turn off the unit, and check for any obstructions on any of the air inlet or outlet vents. Restart the unit, if the malfunction is still present, turn off the unit and unplug the power cord.

Contact the manufacturer, its service agents or a similar qualified person for service.

5. TIMER Button

Used to initiate the AUTO ON start time and AUTO OFF stop time program in conjunction with the UP & DOWN buttons. The timer on/off indicator light illuminates under the timer on/off settings.

6. SWING Mode

Used to initiate the Auto swing feature. When the operation is ON, press the SWING button to stop the louver at the desired angle.

7. CONTINUOUS FAN Function

In Cool or Dry mode, press and hold the Continuous Fan button for 3 seconds to turn the continuous fan function on or off. When the function is turned on, the continuous fan light will illuminate. When the function is turned off, the continuous fan light will turn off.

To control the fan speed, press the Continuous Fan button in four steps - LOW, MED, HIGH and AUTO.

The fan speed indicator light will illuminate under different fan settings.

8. SLEEP Mode

Press the sleep button to initiate sleep mode. While in this mode, the selected temperature will increase or decrease by 2°F (or 1°C) after 30 minutes.

The temperature will then increase or decrease by another 2°F (or 1°C) after an additional 30 minutes.

This new temperature will be maintained for 7 hours before it returns to the originally selected temperature. After the 7 hour period, sleep mode is automatically turned off and the unit will continue to operate as originally programmed.

NOTICE

This feature is unavailable under FAN or DRY mode.

9. DRY Mode

To turn on Dry mode, press the "MODE" button until the "Dry" indicator light comes on. In this mode, the fan speed or the temperature cannot be adjusted.

The fan motor operates at LOW speed.

NOTICE

Keep windows and doors closed for the best dehumidifying effect.

10. AUTO Mode

When you set the air conditioner to AUTO mode, it will automatically select cooling, heating (heat function only on some models), or fan only operation depending on what temperature you have selected and the room temperature. To turn on Auto mode, press the "MODE" button until the "Auto" indicator light comes on.

The air conditioner will control room temperature automatically around the temperature point set by you. Under AUTO mode, you can not select the fan speed.

NOTICE

Under AUTO mode, both the AUTO mode and the actual operation mode indicator lights illuminate for some models.

11. COOL Mode

To turn on Cool mode, press the "MODE" button until the "Cool" indicator light comes on.

Press the ADJUST buttons UP (^ /+) or DOWN (v /-) to select your desired room temperature.

The temperature can be set within a range of 16°C-30°C/60°F-86°F(or 88°F).

Press the "FAN SPEED" button to choose the fan speed.

12. FAN Mode

To turn on Fan mode, press the "MODE" button until the "Fan" indicator light comes on.

13. ComfortSense

To activate the ComfortSense feature, point the remote control towards the unit and press the ComfortSense button. The remote's display will show actual temperature at its location and must be within 26 feet of the air conditioner to work. The remote control will send this signal to the air conditioner every 3 minutes until the ComfortSense button is pressed again. If the unit does not receive the ComfortSense signal during any 7 minute interval, the unit will beep to indicate the ComfortSense mode has ended.

Drainage Guide

During dehumidifying mode, remove the upper drain plug from the back of the unit, install the drain connector (5/8" universal female mender) with 3/4" hose (not included).

For the models without drain connector, just attach the drain hose to the hole. Place the open end of the hose directly over the drain area in your basement floor. During heat pump mode(only on some models), remove the lower drain plug from the back of the unit, install the drain connector.

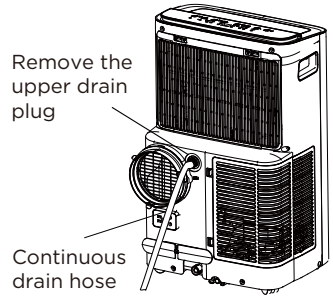

NOTICE

Make sure the hose is secure so there are no leaks. Direct the hose toward the drain, making sure that there are no kinks that will stop the water flowing. Place the end of the hose into the drain and make sure the end of the hose is down to let the water flow smoothly. When the continuous drain hose is not used, ensure that the corresponding drain plug and knob are installed firmly to prevent leakage.

During heat pump mode(only on some models), remove the lower drain plug from the back of the unit, install the drain connector (5/8" universal female mender) with 3/4" hose (not included).

Carefully move the unit to a drain location, and let the water drain away.

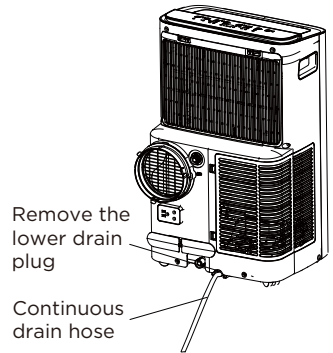

NOTICE

Make sure the drain hose is lower than the bottom tray drain outlet.

When the water level of the bottom tray reaches a predetermined level, the unit beeps 8 times, the digital display area shows "P1". At this time the air conditioning/dehumidification process will immediately stop. However, the fan motor will continue to operate (this is normal).

Carefully move the unit to a drain location, remove the bottom drain plug and let the water drain away. Reinstall the bottom drain plug and restart the machine until the "P1" symbol disappears. If the error repeats, call for service.

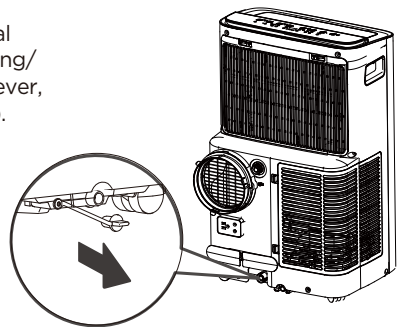

NOTICE

Be sure to reinstall the bottom drain plug firmly to prevent leakage before using the unit.

CLEANING & MAINTENANCE

Air Filter & Cabinet Cleaning

Clean the unit using a damp, lint-free cloth and mild detergent.

Dry the unit with a dry, lint-free cloth.

- Take the filter out along the arrow direction.
- Wash the air filter by immersing it gently in warm water (about 40°C/104°F) with a neutral detergent.
- Rinse the filter and dry it in a shady place.
- Install the air filter after cleaning.

CAUTION

DO NOT operate the unit without filter because dirt and lint will clog it and reduce performance.

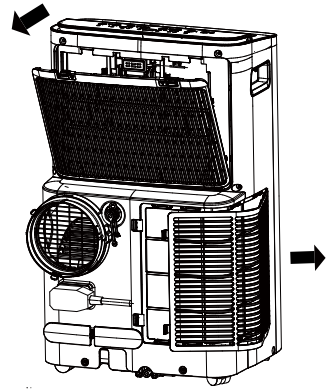

Remove the air filter

Maintenance Tips

- Be sure to clean the air filter every 2 weeks for optimal performance.
- The water collection tray should be drained immediately after P1 error occurs, and before storage to prevent mold.
- In households with animals, you will have to periodically wipe down the grill to prevent blocked airflow due to animal hair.

CAUTION

- Always unplug the unit before cleaning or servicing.
- DO NOT use flammable liquids or chemicals to clean the unit.
- DO NOT wash the unit under running water. Doing so causes electrical danger.
- DO NOT operate the machine if the power supply was damaged during cleaning. A damaged power cord must be replaced with a new cord from the manufacturer.

Store The Unit When Not In Use

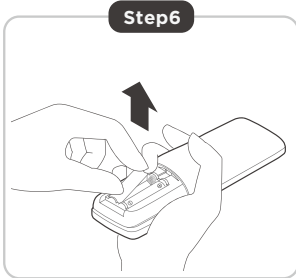
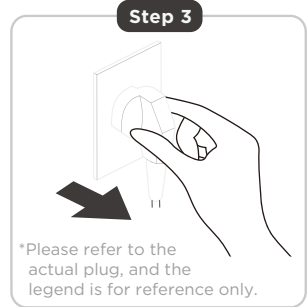
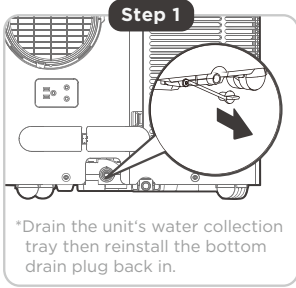

Step 1: Drain the unit's water collection tray according to the instructions on page 20.

Step 2: Run the appliance on FAN mode for 12 hours in a warm room to dry it and prevent mold.

Step 3: Turn off the appliance and unplug it.

Step 4: Clean the machine.

Step 5: Clean the air filter according to the instructions in the previous section. Reinstall the clean, dry filter before storing.

Step 6: Remove the batteries from the remote control.

NOTICE

- Be sure to store the unit in a cool, dark place. Exposure to direct sunshine or extreme heat can shorten the lifespan of the unit.
- The cabinet and front may be dusted with an oil-free cloth or washed with a cloth dampened in a solution of warm water and mild liquid dishwashing detergent. Rinse thoroughly and wipe dry. Never use harsh cleansers, wax or polish on the cabinet front. Be sure to wring excess water from the cloth before wiping around the controls. Excess water in or around the controls may cause damage to the unit.

TROUBLESHOOTING TIPS

Common Issues

The following problems are not a malfunction and in most situations will not require repairs.

Proble	Solution	
Unit does not turn on when pressing ON/OFF button	P1 Protection Code.	The water collection tray is full. Turn off the unit, drain the water from the Water Collection Tray and restart the unit.
	In COOL mode: room temperature is lower than the set temperature.	Check the set temperature.
Unit does not cool well	The air filter is blocked with dust or animal hair.	Turn off the unit and clean the filter according to instructions.
	Exhaust hose is not connected or is blocked.	Turn off the unit, disconnect the hose, check for blockage and reconnect the hose.
	The unit is low on refrigerant.	Call a service technician to inspect the unit and top off refrigerant.
	Temperature setting is too high.	Decrease the set temperature.
	The windows and doors in the room are open.	Make sure all windows and doors are closed.
	The room area is too large.	Double-check the cooling area.
	There are heat sources inside the room.	Remove the heat sources if possible.
The unit is noisy and vibrates too much	The ground is not level	Place the unit on a flat, level surface.
	The air filter is blocked with dust or animal hair.	Turn off the unit and clean the filter according to instructions.
The unit makes a gurgling sound	This sound is caused by the refrigerant flow inside the unit.	This is normal.

REMOTE CONTROL AND APP INSTRUCTIONS

Remote Control Specifications

Model	RG57H4(B2)/BGCEU1
Rated voltage	3.0V (Dry batteries R03/LR03x2)
Signal receiving range	26 ft. (approx. 8 m)
Environment	23°F ~ 140°F (-5°C ~ 60°C)

Function Buttons

Before you begin using your new air conditioner, make sure to familiarize yourself with its remote control. The following is a brief introduction to the remote control itself. For instructions on how to operate your air conditioner, refer to the Operating Instructions section of this manual.

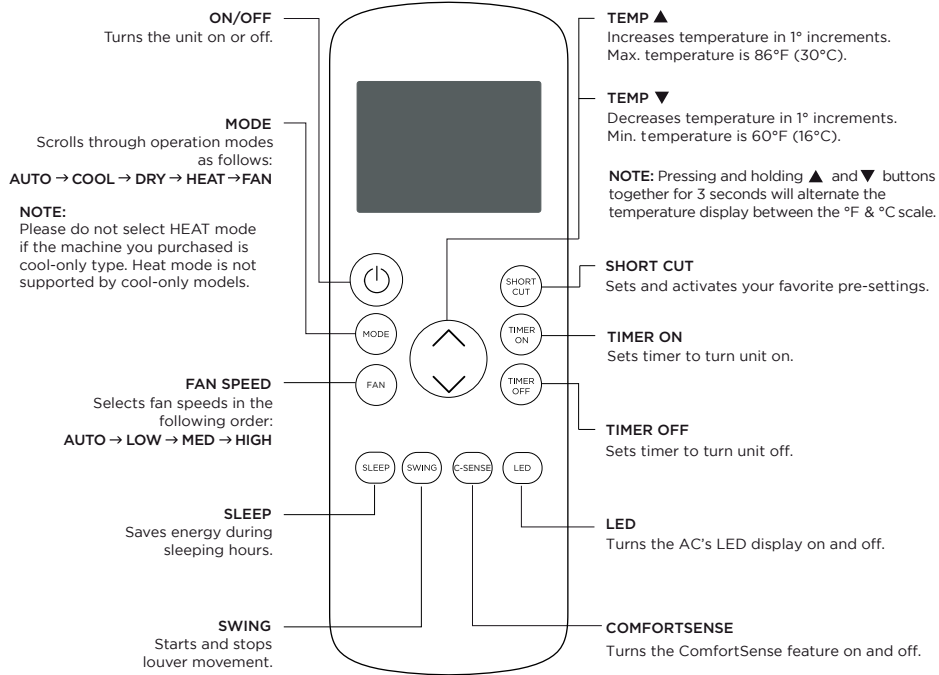

Handling the Remote Control

NOT SURE WHAT A FUNCTION DOES?

Refer to the Operating Instructions section of this manual for a detailed description of the functions available using the remote.

NOTICE

Button designs on your unit may differ slightly from the example shown.

If the unit does not have a specific function, using that function's button on the remote control will have no effect.

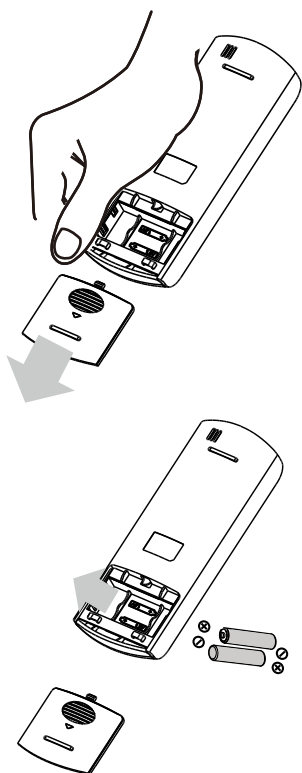

INSERTING AND REPLACING BATTERIES

Your air conditioning unit comes with two AAA batteries. Insert the batteries in the remote control before use.

1. Slide the back cover of the remote control downward, exposing the battery compartment.
2. Insert the batteries, paying attention to align the (+) and (-) ends of the batteries with the symbols inside the battery compartment.
3. Slide the battery cover back into place.

BATTERY NOTES

For optimum product performance:

- Do not mix old and new batteries, or batteries of different types.
- Do not leave batteries in the remote control if you don't plan on using the device for more than 2 months.

BATTERY DISPOSAL

Ensure used batteries are disposed of properly.

TIPS FOR USING REMOTE CONTROL

- The remote control must be used within 26 feet / 8 meters of the unit.
- The unit will beep when it receives a signal from the remote. Curtains, other materials and direct sunlight can interfere with the IR signal receiver.
- In order to properly transmit a command, the ON/OFF indicator must be illuminated on the remote's display. (See the Remote LED Screen Indicators section for more information.)

Basic Functions

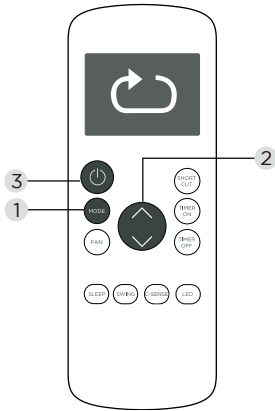

SETTING THE DESIRED TEMPERATURE

The operating temperature range for this unit is 60°F-86°F (16°C-30°C).

You can increase or decrease the set temperature in 1°F or 1°C increments.

Changing the Mode

1. To change the operating mode, press the MODE button until the desired mode appears on the remote's display.
2. Set the desired temperature.

NOTICE

If the unit does not change when the button is pressed, check that the ON/OFF indicator is illuminated. If it is not, point the remote at the unit and press the ON/OFF button.

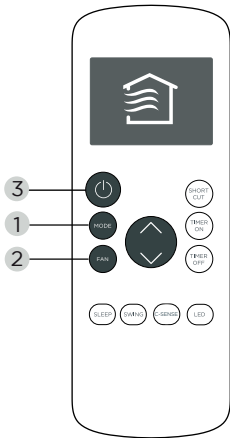

Changing the Fan Speed

To change the fan speed, press the FAN button until the desired fan speed appears on the remote's display.

NOTICE

If the unit does not change when the button is pressed, check that the ON/OFF indicator is illuminated. If it is not, point the remote at the unit and press the ON/OFF button.

Timer Functions

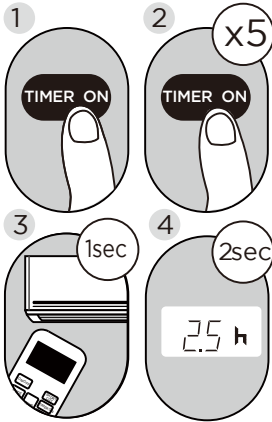

Example: Setting unit to turn on after 2.5 hours.

Your air conditioning unit has two timer-related functions:

TIMER ON - sets the amount of time after which the unit will automatically turn on.

TIMER OFF - sets the amount of time after which the unit will automatically turn off.

TIMER ON Function

The TIMER ON function allows you to set a period of time after which the unit will automatically turn on, such as when you come home from work.

1. Press the TIMER ON button. By default, the last time period that you set and an "h" (indicating hours) will appear on the display.

NOTICE

This number indicates the amount of time after the current time after which you want the unit to turn on.

For example, if you set TIMER ON for 2 hours, "2.0h" will appear on the screen, and the unit will turn on after 2 hours.

2. Press the TIMER ON button repeatedly to set the time that you want the unit to turn on.
3. Wait 2 seconds, then the TIMER ON function will be activated. The digital display on your remote control will then return to the temperature display.

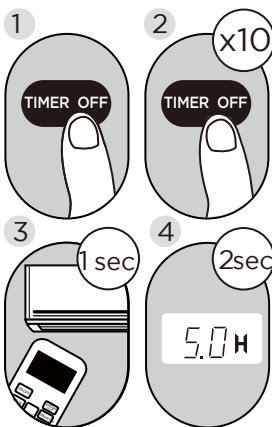

Example: Setting unit to turn off after 5 hours.

TIMER OFF Function

The TIMER OFF function allows you to set a period of time after which the unit will automatically turn off, such as when you wake up.

1. Press the TIMER OFF button. By default, the last time period that you set and an "h" (indicating hours) will appear on the display.

NOTICE

This number indicates the amount of time after the current time after which you want the unit to turn off.

For example, if you set TIMER OFF for 2 hours, "2.0h" will appear on the screen, and the unit will turn off after 2 hours.

2. Press the TIMER OFF button repeatedly to set the time that you want the unit to turn off.

Timer Functions (cont.)

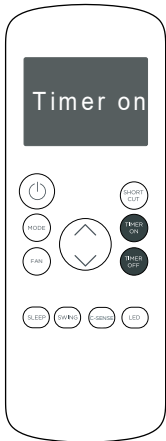

Continue to press **TIMER ON** or **TIMER OFF** until desired time is reached.

- Wait 2 seconds, then the **TIMER OFF** function will be activated. The digital display on your remote control will then return to the temperature display.

NOTICE

When setting the **TIMER ON** or **TIMER OFF** functions, up to 10 hours, the time will increase in 30 minute increments with each press. After 10 hours and up to 24, it will increase in 1 hour increments. The timer will revert to zero after 24 hours. You can turn off either function by setting the timer to "0.0h".

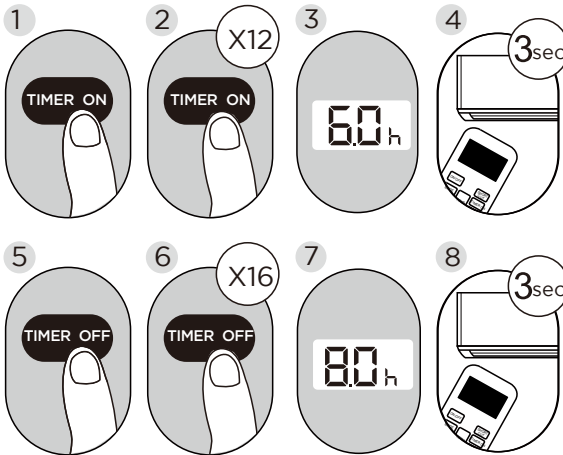

Setting Both **TIMER ON** And **TIMER OFF** At The Same Time

Keep in mind that the time periods you set for both functions refer to hours after the current time. For example, say that the current time is 1:00 PM, and you want the unit to turn on automatically at 7:00 PM and want it to operate for 2 hours, then automatically turn off at 9:00 PM.

Do the following (side figure):

Example: Setting the unit to turn on after 6 hours, operate for 2 hours, then turn off (see the figure below).

Your remote display

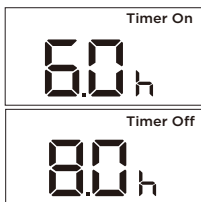

Timer is set To turn ON 6 hours from current time

Timer is set To turn OFF 8 hours from current time

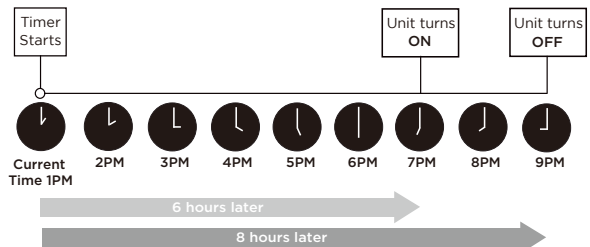

How to Use the Advanced Functions

SLEEP Function

The SLEEP function is used to decrease energy use while you sleep (and don't need the same temperature settings to stay comfortable).

Note: The SLEEP function is not available in FAN or DRY mode.

SWING Function

Used to stop or start louver movement and set the desired up/down air flow direction. The louver angle changes in 6 degree increments with each press (not all models). By pressing for more than 2 seconds, the louver auto swing feature is activated.

COMFORTSENSE Function

The COMFORTSENSE function enables the remote control to measure the temperature at its current location.

When using AUTO, COOL, or HEAT functions, measuring ambient temperature from the remote control (instead of from the indoor unit itself) will enable the air conditioner to optimize the temperature around you and ensure maximum comfort.

1. Press COMFORTSENSE button to activate function.
The remote control will send temperature signal to the unit every three minutes.
2. Press COMFORTSENSE button again to turn off this function.

SHORTCUT Function

- Used to restore the current settings or resume previous settings.
- Push this button when remote controller is on, the system will automatically revert back to the previous settings including operating mode, set temperature, fan speed level and sleep feature (if activated).
- By pressing for more than 2 seconds, the system will automatically store the current operation settings including operating mode, set temperature, fan speed level and sleep feature (if activated).

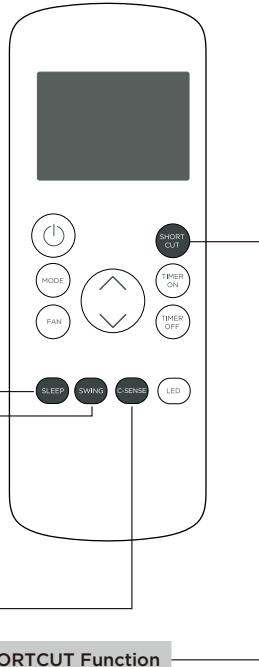

NOTICE

This device complies with part 15 of the FCC Rules. Operation is subject to the following two conditions: (1) This device may not cause harmful interference, and (2) this device must accept any interference received, including interference that may cause undesired operation.

Note: This equipment has been tested and found to comply with the limits for a Class B digital device, pursuant to part 15 of the FCC Rules. These limits are designed to provide reasonable protection against harmful interference in a residential installation. This equipment generates, uses and can radiate radio frequency energy and, if not installed and used in accordance with the instructions, may cause harmful interference to radio communications. However, there is no guarantee that interference will not occur in a particular installation.

If this equipment does cause harmful interference to radio or television reception, which can be determined by turning the equipment off and on, the user is encouraged to try to correct the interference by one or more of the following measures:

- Reorient or relocate the receiving antenna.
- Increase the separation between the equipment and receiver.
- Connect the equipment into an outlet on a circuit different from that to which the receiver is connected.
- Consult the dealer or an experienced radio/TV technician for help.

NOTICE

Declaration of Conformity

CONTAINS FCC ID: 2ADQOMDNA21

CONTAINS IC : 12575A-MDNA21

This device complies with Part 15 of the FCC Rules and it contains license-exempt transmitter(s)/receiver(s) that comply with Innovation, Science and Economic Development Canada's license exempt RSS(s). Operation is subject to the following two conditions:

- (1) This device may not cause interference; and
- (2) This device must accept any interference, including interference that may cause undesired operation of the device.

Only operate the device in accordance with the instructions supplied. Changes or modifications to this unit not expressly approved by the party responsible for compliance could void the user's authority to operate the equipment. This device complies with FCC radiation exposure limits set forth for an uncontrolled environment. In order to avoid the possibility of exceeding the FCC radio frequency exposure limits, human proximity to the antenna shall not be less than 20cm (8 inches) during normal operation.

Note: This equipment has been tested and found to comply with the limits for a Class B digital device, pursuant to part 15 of the FCC Rules. These limits are designed to provide reasonable protection against harmful interference in a residential installation. This equipment generates, uses and can radiate radio frequency energy and, if not installed and used in accordance with the instructions, may cause harmful interference to radio communications. However, there is no guarantee that interference will not occur in a particular installation. If this equipment does cause harmful interference to radio or television reception, which can be determined by turning the equipment off and on, the user is encouraged to try to correct the interference by one or more of the following measures:

- Reorient or relocate the receiving antenna.
- Increase the separation between the equipment and receiver.
- Connect the equipment into an outlet on a circuit different from that to which the receiver is connected.
- Consult the dealer or an experienced radio/TV technician for help.

Company will not be liable for any issues and problems caused by Internet, Wi-Fi/ Wireless Router and Smart Devices. Please contact the original provider to get further help.

Supplier's Declaration of Conformity
47 CFR § 2.1077 Compliance Information

Unique Identifier: RG57H4(B2)/BGCEFU1

Responsible Party U.S. Contact Information

Midea America Corporation
300 Kimball Dr
Parsippany NJ
07054

Telephone number or internet contact information: Midea.com/us

FCC Compliance Statement (products subject to Part 15)

This device complies with Part 15 of the FCC Rules. Operation is subject to the following two conditions: (1) This device may not cause harmful interference, and (2) this device must accept any interference received, including interference that may cause undesired operation.

Declaration of Conformity

We hereby declare that this AC is in compliance with the essential requirements and other relevant provisions of Directive 1999/5/EC.

Specification of Wireless Module

Model: US-SK105	Dimensions: 41 x 24 x 5 (mm)
Antenna Type: Printed PCB Antenna	Operation Temperature: 0°C ~ 45°C / 32°F ~ 113°F
Frequency: WLAN 2400-2483.5 MHz	Operation Humidity: 10% ~ 85%
Maximum Transmitted Power: <20 dBm Max	Power Input: DC 5V/500 mA

PRECAUTIONS

1. Supports operating systems: Please refer to page 35
2. In the event of a OS update, there may be a delay between the update of the OS and a related software update during which your OS may or may not be supported until a new version is released. Your specific mobile phone or problems in your network may prevent the system from working and Midea will not be responsible for any problems that could be caused by incompatibility or network issues.
3. This Smart AC only supports WPA-PSK/WPA2-PSK (recommended) encryption.
4. To ensure proper scanning of the QR code, your smart phone must have at least a 5-megapixel camera.
5. Due to unstable network connectivity, requests may time out. If this happens, rerun the network configuration.
6. Due to unstable network connectivity, commands may time out. If this happens, the smartphone app and the actual product may display conflicting information. The information displayed on the actual product is always the most accurate available. Refresh the app to re-sync.

Device	Version
iPhone	iOS 16.5
Apple Home Pod	16.5
Android	Google Play services min version: 22.36.15 Google Home app (GHA) min version: 2.58.24.1-dogfood
Google Home Hub	Google Hub firmware min version: 1.56.324896 (appears on hub as Chromecast firmware version)
Alexa App	2.2.536317
Alexa Echo Device	9094439556

NOTE:

- Setup processes and features may vary between ecosystems.
- The functions shown in the Alexa, Google Home or Apple Home apps may change with updates to their products or apps.
- Periodically, we will update the device's software to improve the experience.
Device software updates can be accomplished through the SmartHome app.

NOTICE

Midea will not be responsible for any problems that could be caused by incompatibility or network issues, your wireless router and mobile phone.

1 How to use SmartHome App (smart models only)

⚠️ Ensure that your mobile phone is connected to the wireless network. Bluetooth must be turned on. The device must also be powered up.

■ Step 1: Download the SmartHome app

Scan the QR code below to download the SmartHome app from app store or search for it directly on the Google Play Store or Apple's App Store.



■ Step 2: Log in

Open the SmartHome app. Log in directly if you have an existing SmartHome account or create a new account. Alternatively, you can also use a 3rd party login platform.

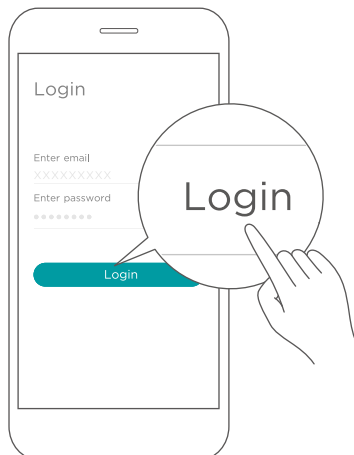

■ Step 3: Connecting the device

1) When you log in, you may see the message "Smart devices discovered nearby". Tap to add your device.



2) If no such message appears, proceed as follows: Tap on "+" and select your device in the list of nearby available devices.
If your device is not listed, please add your device manually, first selecting the device category e.g. Window AC.



3) Follow the steps in the app to connect your device to the wireless network. If your device fails to connect, follow the additional instructions in the app.

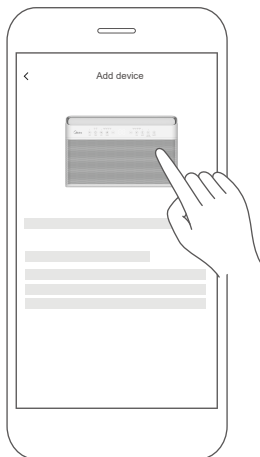

For Window AC



For Portable AC

■ Step 4: Controlling the device

After pairing successfully, a card will be created for the device in the SmartHome app. Shortcuts for basic functions will appear on the card such as changing the temperature or switching the device on or off. Tapping on the card, will reveal additional features and settings. The actual UI design may look different from examples due to app updates.

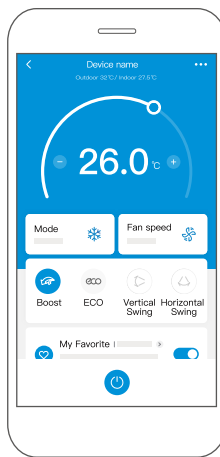
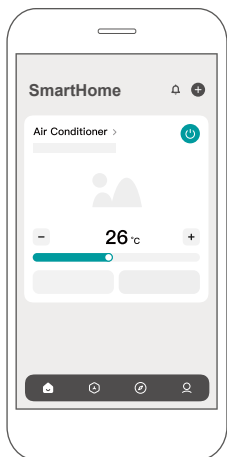



WARNING: Chemical Burn Hazard. Keep batteries away from children.

This product contains a lithium button/coin cell battery. If a new or used lithium button/coin cell battery is swallowed or enters the body, it can cause severe internal burns and can lead to death in as little as 2 hours. Always completely secure the battery compartment. If the battery compartment does not close securely, stop using the product, remove the batteries, and keep it away from children. If you think batteries might have been swallowed or placed inside any part of the body, seek immediate medical attention.



make yourself at home



www.midea.com

© Midea 2023 all rights reserved

CWS002IU-TYN8(GF)

20231125